

STATE OF NORTH CAROLINA  
DEPARTMENT OF TRANSPORTATION  
HIGHWAY DIVISION 5

## ID/IQ Proposal

**DATE AND TIME OF BID OPENING:** May 8, 2024 AT 2:00 PM

**CONTRACT ID:** ME00064

**WBS ELEMENT NO.:** VARIOUS

**FEDERAL AID NO.:** STATE FUNDED

**COUNTY:** Franklin, Vance, and Warren Counties

**TIP NO.:** N/A

**MILES:** VARIOUS

**ROUTE NO.:** VARIOUS

**LOCATION:** VARIOUS

★ **TYPE OF WORK:** PIPE, DRAINAGE, INCIDENTAL CONCRETE, PAVING ★

**NOTICE:**

ALL BIDDERS SHALL COMPLY WITH ALL APPLICABLE LAWS REGULATING THE PRACTICE OF GENERAL CONTRACTING AS CONTAINED IN CHAPTER 87 OF THE GENERAL STATUTES OF NORTH CAROLINA WHICH REQUIRES THE BIDDER TO BE LICENSED BY THE N.C. LICENSING BOARD FOR CONTRACTORS WHEN BIDDING ON ANY NON-FEDERAL AID PROJECT WHERE THE BID IS \$30,000 OR MORE, EXCEPT FOR CERTAIN SPECIALTY WORK AS DETERMINED BY THE LICENSING BOARD. BIDDERS SHALL ALSO COMPLY WITH ALL OTHER APPLICABLE LAWS REGULATING THE PRACTICES OF ELECTRICAL, PLUMBING, HEATING AND AIR CONDITIONING AND REFRIGERATION CONTRACTING AS CONTAINED IN CHAPTER 87 OF THE GENERAL STATUTES OF NORTH CAROLINA. NOTWITHSTANDING THESE LIMITATIONS ON BIDDING, THE BIDDER WHO IS AWARDED ANY FEDERAL - AID FUNDED PROJECT SHALL COMPLY WITH CHAPTER 87 OF THE GENERAL STATUTES OF NORTH CAROLINA FOR LICENSING REQUIREMENTS WITHIN 60 CALENDAR DAYS OF BID OPENING.

THIS IS A ROADWAY PROJECT.

BID BOND IS NOT REQUIRED.

---

NAME OF BIDDER

---

ADDRESS OF BIDDER

**PROPOSAL FOR THE CONSTRUCTION OF  
CONTRACT No. ME00064 IN Franklin, Vance, and Warren Counties, NORTH CAROLINA  
DEPARTMENT OF TRANSPORTATION,  
RALEIGH, NORTH CAROLINA**

The Bidder has carefully examined the location of the proposed work to be known as Contract No. **ME00064**; has carefully examined the plans and specifications, which are acknowledged to be part of the proposal, the special provisions, the proposal, the form of contract; and thoroughly understands the stipulations, requirements and provisions. The undersigned bidder agrees to be bound upon his execution of the bid and subsequent award to him by the Department of Transportation in accordance with this proposal. Payment and performance bonds are not required on this project. The undersigned Bidder further agrees to provide all necessary machinery, tools, labor, and other means of construction; and to do all the work and to furnish all materials, except as otherwise noted, necessary to perform and complete the said contract in accordance with the *2024 Standard Specifications for Roads and Structures* by the dates(s) specified in the Project Special Provisions and in accordance with the requirements of the Engineer, and at the unit or lump sum prices, as the case may be, for the various items given on the sheets contained herein.

The Bidder shall provide and furnish all the materials, machinery, implements, appliances and tools, and perform the work and required labor to construct and complete Contract No. **ME00064** in **Franklin, Vance, and Warren Counties**, for the unit or lump sum prices, as the case may be, bid by the Bidder in his bid and according to the proposal, plans, and specifications prepared by said Department, which proposal, plans, and specifications show the details covering this project, and hereby become a part of this contract.

The published volume entitled *North Carolina Department of Transportation, Raleigh, Standard Specifications for Roads and Structures, January 2024* with all amendments and supplements thereto, is by reference incorporated into and made a part of this contract; that, except as herein modified, all the construction and work included in this contract is to be done in accordance with the specifications contained in said volume, and amendments and supplements thereto, under the direction of the Engineer.

If the proposal is accepted and the award is made, the contract is valid only when signed either by the Contract Officer or such other person as may be designated by the Secretary to sign for the Department of Transportation. The conditions and provisions herein cannot be changed except over the signature of the said Contract Officer or Division Engineer.

The quantities shown in the itemized proposal for the project are considered to be approximate only and are given as the basis for comparison of bids. The Department of Transportation may increase or decrease the quantity of any item or portion of the work as may be deemed necessary or expedient.

An increase or decrease in the quantity of an item will not be regarded as sufficient ground for an increase or decrease in the unit prices, nor in the time allowed for the completion of the work, except as provided for the contract.

## TABLE OF CONTENTS

### **COVER SHEET PROPOSAL SHEET**

### **PROJECT SPECIAL PROVISIONS**

GENERAL:.....	G-1
SCOPE:.....	G-1
INTERESTED PARTIES LIST NOT REQUIRED:.....	G-1
BOND REQUIREMENTS – No Bonds Required .....	G-1
DIVISION LET CONTRACT PREQUALIFICATION: .....	G-1
CONTRACT TIME FOR ID/IQ:.....	G-2
INTERMEDIATE CONTRACT TIME NUMBER 1 AND LIQUIDATED DAMAGES: .....	G-2
INTERMEDIATE CONTRACT TIME NUMBER 2 AND LIQUIDATED DAMAGES: .....	G-3
INTERMEDIATE CONTRACT TIME NUMBER 3 AND LIQUIDATED DAMAGES: .....	G-5
NON-EXCLUSIVE CONTRACT: .....	G-6
WORK ORDER ASSIGNMENT (MULTIPLE AWARDS) FOR ID/IQ:.....	G-6
BONDING REQUIREMENTS FOR ID/IQ:.....	G-6
MOBILIZATION AND LIQUIDATED DAMAGES FOR ID/IQ:.....	G-7
MULTI-YEAR MAINTENANCE CONTRACTS (ID/IQ):.....	G-8
RENEWAL OF CONTRACT (CPI PRICE ADJUSTMENT) FOR ID/IQ: .....	G-8
DISPUTE RESOLUTION PROCESS FOR ID/IQ: .....	G-8
NO MAJOR CONTRACT ITEMS: .....	G-9
NO SPECIALTY ITEMS: .....	G-9
FUEL PRICE ADJUSTMENT PAPER BID: .....	G-9
SCHEDULE OF ESTIMATED COMPLETION PROGRESS: .....	G-11
MINORITY BUSINESS ENTERPRISE AND WOMEN BUSINESS ENTERPRISE (DIVISIONS):.....	G-11
RESTRICTIONS ON ITS EQUIPMENT AND SERVICES: .....	G-26
USE OF UNMANNED AIRCRAFT SYSTEM (UAS):.....	G-26
EQUIPMENT IDLING GUIDELINES:.....	G-27
OUTSOURCING OUTSIDE THE USA:.....	G-27
PROCEDURE FOR MONITORING BORROW PIT DISCHARGE: .....	G-28
NOTIFICATION OF OPERATIONS: .....	G-29
PROGRESS AND PROSECUTION:.....	G-29
UTILITY CONFLICTS:.....	G-29
WORK SITE CLEANUP: .....	G-30
PAYMENT AND RETAINAGE: .....	G-30
TOLL FACILITY REIMBURSEMENT:.....	G-31
TOLL TRAFFIC COORDINATION:.....	G-31
 ROADWAY.....	 R-1

### **STANDARD SPECIAL PROVISIONS**

AVAILABILITY OF FUNDS – TERMINATION OF CONTRACTS .....	SSP-1
NCDOT GENERAL SEED SPECIFICATION FOR SEED QUALITY .....	SSP-2

ERRATA .....SSP-5  
PLANT AND PEST QUARANTINES .....SSP-6  
MINIMUM WAGES .....SSP-7  
TITLE VI AND NONDISCRIMINATION: .....SSP-8  
ON-THE-JOB TRAINING.....SSP-17

**UNIT PROJECT SPECIAL PROVISIONS**

EROSION CONTROL.....EC-1

**SIGNATURE SHEETS AND FORMS** .....S-1  
**BID/PAY ITEM SHEETS** .....T-1

## INSTRUCTIONS TO BIDDERS

### PLEASE READ ALL INSTRUCTIONS CAREFULLY BEFORE PREPARING AND SUBMITTING YOUR BID.

All bids shall be prepared and submitted in accordance with the following requirements. Failure to comply with any requirement may cause the bid to be considered irregular and may be grounds for rejection of the bid.

#### TRADITIONAL PAPER BIDS:

1. Download the entire proposal from the Connect NCDOT website and return the entire proposal with your bid.
2. In accordance with Article 102-3 of the *Standard Specifications*, registration on the Interested Parties List is required unless SP1 G02 Interested Parties List Not Required provision is included in the proposal.
3. All entries on the itemized proposal sheet (bid form) shall be written in ink or typed.
4. The Bidder shall submit a unit price for every item on the itemized proposal sheet. The unit prices for the various contract items shall be written in figures. Unit prices shall be rounded off by the Bidder to contain no more than FOUR decimal places.
5. An amount bid shall be entered on the itemized proposal sheet for every item. The amount bid for each item shall be determined by multiplying each unit bid by the quantity for that item, and shall be written in figures in the "Amount" column of the form.
6. The total amount bid shall be written in figures in the proper place on the bid form. The total amount bid shall be determined by adding the amounts bid for each item.
7. Changes to any entry shall be made by marking through the entry in ink and making the correct entry adjacent thereto in ink. A representative of the Bidder shall initial the change in ink. Do not use correction fluid, correction tape or similar product to make corrections.
8. The bid shall be properly executed on the included **Execution of Bid – Non-collusion, Debarment and Gift Ban Certification** form. All bids shall show the following information:
  - a. Name of corporation, partnership, Limited Liability Company, joint venture, individual or firm, submitting bid.  
Corporations that have a corporate seal shall include it on the bid, otherwise write your corporations name in the seal location.
  - b. Name of individual or representative submitting bid and position or title held on behalf of the bidder.
  - c. Name, signature, and position or title of witness.
9. The bid shall not contain any unauthorized additions, deletions, or conditional bids.
10. The Bidder shall not add any provision reserving the right to accept or reject an award, or to enter into a contract pursuant to an award.
11. **THE PROPOSAL WITH THE ITEMIZED PROPOSAL SHEET ATTACHED SHALL BE PLACED IN A SEALED ENVELOPE AND SHALL BE DELIVERED TO AND RECEIVED IN THE NCDOT DIVISION CONTRACT ENGINEER'S OFFICE, LOCATED AT 1020 BIRCH RIDGE DRIVE, DOOR B6, RALEIGH, NC 27610, BY 2:00 PM ON May 8, 2024.**

12. The sealed bid must display the following statement on the front of the sealed envelope:

**QUOTATION FOR – ME00064 TO BE OPENED AT 2:00 PM ON MAY 8, 2024.**

13. If delivered by mail to the Mail Service Center address listed below, the Contractor should allow adequate time for the bid to be routed internally and physically delivered to the Contracts Engineer's Office as listed under Item 11 above. Internal routing and delivery from the Mail Service Center to the Contracts Engineer's Office may take up to three (3) days. The bids must be received by the Division Contract Engineer at the address and time listed above under Item 11. Bids that are not received by this time shall not be considered and will be returned to the Contractor unopened. The sealed envelope shall be placed in another sealed envelope and the outer envelope shall be addressed as follows:

**N. C. DEPARTMENT OF TRANSPORTATION  
1573 Mail Service Center  
Raleigh, NC 27699-1573**

**ATTN: Michael J. Biedell, PE  
Division 5 Contract Engineer  
1020 Birch Ridge Dr., Door B6  
Raleigh, NC 27610**

**13.** Questions should be emailed 7 calendar days prior to the bid opening to Michael J. Biedell, PE at [mbiedell@ncdot.gov](mailto:mbiedell@ncdot.gov). Contact with any other NCDOT personnel concerning this project is strictly prohibited, unless otherwise noted, and may result in bids being considered non-responsive.

**PROJECT SPECIAL PROVISIONS****GENERAL****SCOPE:**

This contract is for annual needs for miscellaneous concrete work in District 3 in Franklin, Vance, and Warren Counties. The Contractor will also be responsible for pipe installation, minor widening, patching, erosion control and traffic control, as directed by the Engineer. At the Engineer's discretion the Department may elect to provide traffic control for certain locations.

All work and materials shall be in accordance with the provisions of the General Guidelines of this contract, the Project Special Provisions, the North Carolina Department of Transportation *2024 Standard Specifications for Roads and Structures*, the North Carolina Department of Transportation *2024 Roadway Standards Drawings*, and the current edition of the *Manual of Uniform Traffic Control Devices (MUTCD)*, with the exception that bid bonds are *not* required.

The Contractor shall keep himself fully informed of all Federal, State and local laws, ordinances, and regulations, and shall comply with the provisions of Section 107 of the *2024 Standard Specifications*.

**INTERESTED PARTIES LIST NOT REQUIRED:**

(6-21-22)(Rev. 2-20-24)

102

SP1 G02

Revise the *Standard Specifications* as follows:

The *Interested Parties List* sign up process is not applicable to this contract.

**Page 1-13, Article 102-3 PROPOSALS AND INTERESTED PARTIES LIST, lines 12-15,** delete the first paragraph.

**Page 1-14, Article 102-8 PREPARATION AND SUBMISSION OF BIDS, lines 43-44,** delete the first sentence of the first paragraph.

**BOND REQUIREMENTS – No Bonds Required**

(6-1-16)(Rev. 1-16-24)

SPD 01-420B

The provisions of Articles 102-10 and 103-7 of the *Standard Specifications* are waived for this project. No bonds required.

**DIVISION LET CONTRACT PREQUALIFICATION:**

(07-01-14)(12-1-16)

SPD 01-410

Any firm that wishes to bid as a prime contractor shall be prequalified as a Bidder or PO Prime Contractor prior to submitting a bid. Information regarding prequalification can be found at: <https://connect.ncdot.gov/business/Prequal/Pages/default.aspx>.

Prior to performing the work, the prime contractor and/or subcontractor(s) shall be prequalified in the work code(s) which are identified as work items in the prime contractor's construction progress schedule that they will complete themselves. Any contractor identified as working outside their expertise may be considered in default of the contract.

**CONTRACT TIME FOR ID/IQ:**

(2-15-22)

108

SPI G11

The date of availability for this contract is **June 16, 2024**.

The completion date for this contract is **June 15, 2025**.

Except where otherwise provided by the contract, observation periods required by the contract will not be a part of the work to be completed by the completion date and/or intermediate contract times stated in the contract. The acceptable completion of the observation periods that extend beyond the final completion date shall be a part of the work covered by the performance and payment bonds.

Work shall be accomplished in a continuous manner once the contractor begins.

Any liquidated damages for this contract will be assessed per the Mobilization and Liquidated Damages provision located elsewhere in this Contract.

**INTERMEDIATE CONTRACT TIME NUMBER (1) AND LIQUIDATED DAMAGES:**

(2-20-07)

108

SPI G14 A

The Contractor shall complete the required work of installing, maintaining, and removing the traffic control devices for lane closures and restoring traffic to the existing traffic pattern. The Contractor shall not close or narrow a lane of traffic on **ALL ROUTES EXCEPT INTERSTATE AND TOLL FACILITIES** during the following time restrictions or as directed by the Engineer:

DAY AND TIME RESTRICTIONS

**MONDAY THRU FRIDAY 6:00 A.M. TO 9:00 A.M.**  
**MONDAY THRU FRIDAY 4:00 P.M. TO 7:00 P.M.**

In addition, the Contractor shall not close or narrow a lane of traffic on **ALL ROUTES EXCEPT INTERSTATE AND TOLL FACILITIES**, detain and/or alter the traffic flow on or during holidays, holiday weekends, special events, or any other time when traffic is unusually heavy, including the following schedules:

HOLIDAY AND HOLIDAY WEEKEND LANE CLOSURE RESTRICTIONS

1. For **unexpected occurrence** that creates unusually high traffic volumes, as directed by the Engineer.
2. For **New Year's Day**, between the hours of **6:00 a.m.** December 31st and **7:00 p.m.** January 2nd. If New Year's Day is on a Friday, Saturday, Sunday or Monday, then until **7:00 p.m.** the following Tuesday.



3. For **Easter**, between the hours of **6:00 a.m.** Thursday and **7:00 p.m.** Monday.
4. For **Memorial Day**, between the hours of **6:00 a.m.** Friday and **7:00 p.m.** Tuesday.
5. For **Independence Day**, between the hours of **6:00 a.m.** the day before Independence Day and **7:00 p.m.** the day after Independence Day.

If **Independence Day** is on a Friday, Saturday, Sunday or Monday, then between the hours of **6:00 a.m.** the Thursday before Independence Day and **7:00 p.m.** the Tuesday after Independence Day.

6. For **Labor Day**, between the hours of **6:00 a.m.** Friday and **7:00 p.m.** Tuesday.
7. For **Thanksgiving Day**, between the hours of **6:00 a.m.** Tuesday and **7:00 p.m.** Monday.
8. For **Christmas**, between the hours of **6:00 a.m.** the Friday before the week of Christmas Day and **7:00 p.m.** the following Tuesday after the week of Christmas Day.
9. For events that are significant traffic generators from **one (1) hour before** the event to **one (1) hour after** the event, as directed by the Engineer.

Holidays and holiday weekends shall include New Year's, Easter, Memorial Day, Independence Day, Labor Day, Thanksgiving, and Christmas. The Contractor shall schedule his work so that lane closures will not be required during these periods, unless otherwise directed by the Engineer.

The time of availability for this intermediate contract work shall be the time the Contractor begins to install all traffic control devices for lane closures according to the time restrictions listed herein.

The completion time for this intermediate contract work shall be the time the Contractor is required to complete the removal of all traffic control devices for lane closures according to the time restrictions stated above and place traffic in the existing traffic pattern.

The liquidated damages are **Two Hundred Fifty Dollars (\$250.00)** per fifteen minutes or portion thereof.

**INTERMEDIATE CONTRACT TIME NUMBER (2) AND LIQUIDATED DAMAGES:**

(2-20-07)

108

SPI G14 A

The Contractor shall complete the required work of installing, maintaining, and removing the traffic control devices for lane closures and restoring traffic to the existing traffic pattern. The Contractor shall not close or narrow a lane of traffic on **INTERSTATE FACILITIES** during the following time restrictions or as directed by the Engineer:

DAY AND TIME RESTRICTIONS

**MONDAY THRU SUNDAY 6:00 A.M. TO 9:00 P.M.**

In addition, the Contractor shall not close or narrow a lane of traffic on **INTERSTATE FACILITIES**, detain and/or alter the traffic flow on or during holidays, holiday weekends, special events, or any other time when traffic is unusually heavy, including the following schedules:

HOLIDAY AND HOLIDAY WEEKEND LANE CLOSURE RESTRICTIONS

1. For **unexpected occurrence** that creates unusually high traffic volumes, as directed by the Engineer.
2. For **New Year's Day**, between the hours of **6:00 a.m.** December 31st and **9:00 p.m.** January 2nd. If New Year's Day is on a Friday, Saturday, Sunday or Monday, then until **9:00 p.m.** the following Tuesday.
3. For **Easter**, between the hours of **6:00 a.m.** Thursday and **9:00 p.m.** Monday.
4. For **Memorial Day**, between the hours of **6:00 a.m.** Friday and **9:00 p.m.** Tuesday.
5. For **Independence Day**, between the hours of **6:00 a.m.** the day before Independence Day and **9:00 p.m.** the day after Independence Day.

If **Independence Day** is on a Friday, Saturday, Sunday or Monday, then between the hours of **6:00 a.m.** the Thursday before Independence Day and **9:00 p.m.** the Tuesday after Independence Day.

6. For **Labor Day**, between the hours of **6:00 a.m.** Friday and **9:00 p.m.** Tuesday.
7. For **Thanksgiving Day**, between the hours of **6:00 a.m.** Tuesday and **9:00 p.m.** Monday.
8. For **Christmas**, between the hours of **6:00 a.m.** the Friday before the week of Christmas Day and **9:00 p.m.** the following Tuesday after the week of Christmas Day.
9. For events that are significant traffic generators from **one (1) hour before** the event to **one (1) hour after** the event, as directed by the Engineer.

Holidays and holiday weekends shall include New Year's, Easter, Memorial Day, Independence Day, Labor Day, Thanksgiving, and Christmas. The Contractor shall schedule his work so that lane closures will not be required during these periods, unless otherwise directed by the Engineer.

The time of availability for this intermediate contract work shall be the time the Contractor begins to install all traffic control devices for lane closures according to the time restrictions listed herein.

The completion time for this intermediate contract work shall be the time the Contractor is required to complete the removal of all traffic control devices for lane closures according to the time restrictions stated above and place traffic in the existing traffic pattern.

The liquidated damages are **One Thousand Two Hundred Fifty Dollars (\$1,250.00)** per fifteen minutes or portion thereof.

**INTERMEDIATE CONTRACT TIME NUMBER (3) AND LIQUIDATED DAMAGES:**

(2-20-07)

108

SP1 G14 A

The Contractor shall complete the required work of installing, maintaining, and removing the traffic control devices for lane closures and restoring traffic to the existing traffic pattern. The Contractor shall not close or narrow a lane of traffic on **TOLL FACILITIES** or a shoulder on **INTERSTATE AND TOLL FACILITIES** during the following time restrictions or as directed by the Engineer:

**DAY AND TIME RESTRICTIONS****MONDAY THRU FRIDAY 6:00 A.M. TO 9:00 A.M.****MONDAY THRU FRIDAY 4:00 P.M. TO 7:00 P.M.**

In addition, the Contractor shall not close or narrow a lane of traffic on **TOLL FACILITIES** or a shoulder on **INTERSTATE AND TOLL FACILITIES**, detain and/or alter the traffic flow on or during holidays, holiday weekends, special events, or any other time when traffic is unusually heavy, including the following schedules:

**HOLIDAY AND HOLIDAY WEEKEND LANE CLOSURE RESTRICTIONS**

1. For **unexpected occurrence** that creates unusually high traffic volumes, as directed by the Engineer.
2. For **New Year's Day**, between the hours of **6:00 a.m.** December 31st and **7:00 p.m.** January 2nd. If New Year's Day is on a Friday, Saturday, Sunday or Monday, then until **7:00 p.m.** the following Tuesday.
3. For **Easter**, between the hours of **6:00 a.m.** Thursday and **7:00 p.m.** Monday.
4. For **Memorial Day**, between the hours of **6:00 a.m.** Friday and **7:00 p.m.** Tuesday.
5. For **Independence Day**, between the hours of **6:00 a.m.** the day before Independence Day and **7:00 p.m.** the day after Independence Day.  
  
If **Independence Day** is on a Friday, Saturday, Sunday or Monday, then between the hours of **6:00 a.m.** the Thursday before Independence Day and **7:00 p.m.** the Tuesday after Independence Day.
6. For **Labor Day**, between the hours of **6:00 a.m.** Friday and **7:00 p.m.** Tuesday.
7. For **Thanksgiving Day**, between the hours of **6:00 a.m.** Tuesday and **7:00 p.m.** Monday.
8. For **Christmas**, between the hours of **6:00 a.m.** the Friday before the week of Christmas Day and **7:00 p.m.** the following Tuesday after the week of Christmas Day.
9. For events that are significant traffic generators from **one (1) hour before** the event to **one (1) hour after** the event, as directed by the Engineer.

Holidays and holiday weekends shall include New Year's, Easter, Memorial Day, Independence Day, Labor Day, Thanksgiving, and Christmas. The Contractor shall schedule his work so that lane closures will not be required during these periods, unless otherwise directed by the Engineer.

The time of availability for this intermediate contract work shall be the time the Contractor begins to install all traffic control devices for lane closures according to the time restrictions listed herein.

The completion time for this intermediate contract work shall be the time the Contractor is required to complete the removal of all traffic control devices for lane closures according to the time restrictions stated above and place traffic in the existing traffic pattern.

The liquidated damages are **One Thousand Two Hundred Fifty Dollars (\$1,250.00)** per fifteen minutes or portion thereof.

**NON-EXCLUSIVE CONTRACT:**

(6-1-15)

SPD 01-750

The Department may, as it deems to be in the best interest of the state and the Department of Transportation, execute more than one contract based on this proposal. The Contractor(s) understands and agrees, by signature on the Purchase Order Contract Bid Proposal, that this agreement does not constitute an exclusive contract. If awarded, the contracts will be executed with the lowest responsible bidders. The Department of Transportation reserves the right to make multiple awards for the services provided by this contract. Furthermore, the Department reserves the right to reject all bids received.

**WORK ORDER ASSIGNMENT (MULTIPLE AWARDS) FOR ID/IQ:**

(2-15-22)(Rev. 4-19-22)

SPD 01-800B

Work orders will be assigned based on the lowest work order cost for the line items and estimated quantities necessary to complete the work order. Unit prices from each awarded contractor's bid will be used to determine the lowest cost for each work order. The assigned Contractor shall respond to the work order assignment with the anticipated start date, within three working days of notification unless noted otherwise. Failure on the part of the Contractor to reply within the specified time frame may be received as a rejection of the work order. If the Contractor with the lowest work order cost cannot complete the work within the time specified in the assignment, the Engineer may contact the Contractor with the next lowest work order cost. If that Contractor can complete the work within the time specified in the assignment, then the work order will be assigned to that contractor. If not, assignment of work order will continue in order of work order cost until all awarded Contractors have had a chance to accept the terms of the assignment.

For federal ID/IQ contracts, all work orders will be assigned via the Work Order Assignment form (Form IDIQ-1MA), and the Contractor is required to formally respond in writing for federal work orders within three working days, unless noted otherwise. The Work Order Assignment form will also be used for any state ID/IQ contract in which the estimated work order cost meets the threshold for Performance and Payment Bonds in accordance with the Bonding Requirements for ID/IQ provision found elsewhere in this contract. For state ID/IQ contracts in which the work order assignment doesn't meet the threshold for bonds, the Department has the option to use the Work Order Assignment Form or other methods for work order assignments as agreed upon by the Engineer and Contractor.

The Contractor shall be required to prosecute the work in a continuous and uninterrupted manner from the time they begin the work until completion and final acceptance of the work order. Multiple failures of the Contractor to mobilize and begin work on the work order within the agreed upon time frame or failure to complete the work within the given time frame may result in the Contractor being excluded from future work on this contract in accordance with the *Standard Specifications*.

#### **BONDING REQUIREMENTS FOR ID/IQ:**

(2-15-22)

SPD 01-810

For purposes of this ID/IQ contract, the following definitions apply:

**Project Agreement:** A transportation improvement with a defined scope of work; a written agreement between NCDOT and the Federal Government defining the extent of construction work to be undertaken in accordance with the submitted plans, specifications and estimates. Execution of the agreement prompts the authorization to proceed (construction funding).

**Project:** An undertaking issued to a contractor through a Work Order Assignment. The construction under a Project Agreement may be accomplished by one or more work order assignments, from one or more ID/IQ contracts. Note that for ID/IQ contracts this definition supersedes the definition in the Standard Specifications.

**Award:** The issuance of a signed Work Order Assignment by NCDOT shall constitute the notice of award of a project.

In accordance with North Carolina General Statute 44A-26, bonds are required on contracts awarded for any one project that exceeds \$500,000. Beyond statutory requirements, NCDOT policy requires payment and performance bonds on all projects where the engineer's estimate is \$450,000 or greater, all Asphalt Surface Treatment projects, and projects containing the 12-month guarantee provision. The limit for waiving bonds for all bridge replacement and major bridge rehabilitation projects (latex overlays, etc.) is \$300,000 based on the engineer's estimate. The decision of bonding of a work order assignment below the dollar amounts listed shall be at the discretion of the Division's evaluation of the risks associated with the project.

The need for contract payment and performance bonds will be determined at the Work Order Assignment level. The Work Order Assignment will notify the Contractor of an award of a project and if required, to provide contract payment and performance bonds per Article 103-7 of the *Standard Specifications*. The Work Order Assignment replaces the Notification of Award Letter mentioned in Article 103-4(A) of the *Standard Specifications*.

#### **MOBILIZATION AND LIQUIDATED DAMAGES FOR ID/IQ:**

(2-15-22)

SPD 01-820

The Contractor shall mobilize to each location he is required to perform work. There will be no direct pay for Mobilization as it will be incidental to the other bid items. The only exception is if there is an Emergency Mobilization provision within the contract.

The Contractor will be provided a Work Order Assignment for each project with location(s), estimated quantities, and liquidated damages unless waived by the Engineer. Notification will be

verbal followed by a faxed or emailed signed Work Order Assignment. There will be no minimum quantities for any line item associated with a particular mobilization. The Contractor shall complete the work identified on each Work Order Assignment.

The Contractor shall mobilize and complete the work within the time specified on the Work Order Assignment. Failure to complete the work by the completion date may result in the application of liquidated damages. Liquidated damage amounts will be based on the work order estimate and the liquidated damage table below.

<b>Work Order Value</b>	<b>Liquidated Damages (per calendar day)</b>
\$0 - \$100K	\$100.00
\$100K - \$200K	\$250.00
\$200K - \$300K	\$500.00
\$300K - \$500K	\$600.00
\$500K - \$1M	\$700.00
\$1M - \$2M	\$850.00

#### **MULTI-YEAR MAINTENANCE CONTRACTS (ID/IQ):**

(4-20-21)(Rev. 4-19-22)

SP1 G75

This contract is a multi-year maintenance contract let pursuant to the provisions of N.C. General Statute §136-28.1(b). No minimum quantity of services is guaranteed to be awarded to bidders under this contract. In accordance with N.C. General Statute §136-28.1(b), an award in a maintenance contract may be for an amount less but shall not exceed \$5,000,000 per year. No payments in excess of this amount will be disbursed, in accordance with the Statute.

#### **RENEWAL OF CONTRACT (CPI PRICE ADJUSTMENT) FOR ID/IQ:**

(2-15-22)(Rev. 9-19-23)

SPD 01-840

The Contractor shall submit a bid for one year. At the option of the Department, this contract may be extended for **Two (2)** additional periods of one year each (maximum (3) three years total). Each year shall have a limit of **Five Million Dollars (\$5,000,000)**.

The compensation payable to the contractor shall be fixed for the first twelve months of this contract. However, upon an application of renewal of the contract, or thirty days prior to the end of each contract period, the renewal contract may be adjusted to reflect the adjustment in the Consumer Price Index over the latest twelve-month period as published by the US Bureau of Labor and Statistics at <http://www.bls.gov/cpi> to be applied to new work order assignments. The Consumer Price Index for All Urban Consumers (CPI-U), US City Average, All Items, 1982-84=100, not seasonally adjusted will be used. If the amount of the requested adjustment is more than ten percent, the Department of Transportation reserves the right to cancel this contract.

CPI adjustment values can be determined using the calculator on the NCDOT Construction website.

This price escalation method will not be applied to items of work that are separately covered under commodity price escalation clauses. No other changes in the terms, conditions, etc. of this contract

will be made when an extension to the contract is implemented. The Engineer will notify the Contractor in writing by **2/15/25** if the contract may be extended. The Contractor must notify the Engineer in writing by **30 days** of his acceptance or rejection of this offer. Failure on the part of the Contractor to reply will be received as a rejection of contract extension.

**DISPUTE RESOLUTION PROCESS FOR ID/IQ:**

(2-15-22)(Rev. 1-16-24)

SPD 01-850

If a question should arise on the contract or assignment of a work order, the contractor should notify the Engineer noted on the assignment documentation or the Division Engineer within 48 hours after the scheduled time of bid opening or work order assignment. The following should be included in the notification if applicable:

- (A) the contract for which bids were solicited;
- (B) the particular law, regulation, or contract specification violated;
- (C) a detailed description of the alleged violation; and
- (D) any other information deemed to be relevant.

Once the initial evaluation has been completed, the contractor may be asked to attend a meeting for further discussion and clarification.

Once a determination has been made, the contractor will be notified of the decision by the Division Engineer. If the decision does not meet the satisfaction of the contractor, they have 24 hours from the Division Engineer's notification to elevate the dispute to the Chief Engineer. The Chief Engineer will make the final decision and will not be subject to further review by NCDOT.

**NO MAJOR CONTRACT ITEMS:**

(2-19-02) (Rev. 8-21-07)

104

SP1 G31

None of the items included in this contract will be major items.

**NO SPECIALTY ITEMS:**

(7-1-95)(Rev. 1-16-24)

108-6

SP1 G34

None of the items included in this contract will be specialty items (see Article 108-6 of the *Standard Specifications*).

**FUEL PRICE ADJUSTMENT PAPER BID:**

(11-15-05)(Rev. 1-16-24)

109-8

SP1 G44

Revise the *Standard Specifications* as follows:

**Page 1-82, Article 109-8, FUEL PRICE ADJUSTMENTS**, add the following:

The base index price for DIESEL #2 FUEL is \$ **2.7635** per gallon. Where any of the following are included as pay items in the contract, they will be eligible for fuel price adjustment.

The pay items and the fuel factor used in calculating adjustments to be made will be as follows:

<b>Description</b>	<b>Units</b>	<b>Fuel Usage Factor Diesel</b>
Unclassified Excavation	Gal/CY	0.29
Borrow Excavation	Gal/CY	0.29
Class IV Subgrade Stabilization	Gal/Ton	0.55
Aggregate Base Course	Gal/Ton	0.55
Sub-Ballast	Gal/Ton	0.55
Erosion Control Stone	Gal/Ton	0.55
Rip Rap, Class _____	Gal/Ton	0.55
Asphalt Concrete Base Course, Type _____	Gal/Ton	0.90 or 2.90
Asphalt Concrete Intermediate Course, Type _____	Gal/Ton	0.90 or 2.90
Asphalt Concrete Surface Course, Type _____	Gal/Ton	0.90 or 2.90
Open-Graded Asphalt Friction Course	Gal/Ton	0.90 or 2.90
Permeable Asphalt Drainage Course, Type _____	Gal/Ton	0.90 or 2.90
Sand Asphalt Surface Course, Type _____	Gal/Ton	0.90 or 2.90
Ultra-thin Bonded Wearing Course	Gal/Ton	0.90 or 2.90
Aggregate for Cement Treated Base Course	Gal/Ton	0.55
Portland Cement for Cement Treated Base Course	Gal/Ton	0.55
> 11" Portland Cement Concrete Pavement	Gal/SY	0.327
Concrete Shoulders Adjacent to > 11" Pavement	Gal/SY	0.327
9" to 11" Portland Cement Concrete Pavement	Gal/SY	0.272
Concrete Shoulders Adjacent to 9" to 11" Pavement	Gal/SY	0.272
< 9" Portland Cement Concrete Pavement	Gal/SY	0.245
Concrete Shoulders Adjacent to < 9" Pavement	Gal/SY	0.245

For the asphalt items noted in the chart as eligible for fuel adjustments, the bidder may include the *Fuel Usage Factor Adjustment Form for Paper Bid* with their bid submission if they elect to use the fuel usage factor. The *Fuel Usage Factor Adjustment Form for Paper Bid* is included toward the end of this paper bid document when asphalt items noted in the chart as eligible for fuel adjustments are part of the project.

Select either 2.90 Gal/Ton fuel factor or 0.90 Gal/Ton fuel factor for each asphalt line item on the *Fuel Usage Factor Adjustment Form for Paper Bid*. The selected fuel factor for each asphalt item will remain in effect for the duration of the contract.

Failure to complete the *Fuel Usage Factor Adjustment Form for Paper Bid* will result in using 2.90 gallons per ton as the Fuel Usage Factor for Diesel for the asphalt items noted above. The contractor will not be permitted to change the Fuel Usage Factor after the bids are submitted.



**SCHEDULE OF ESTIMATED COMPLETION PROGRESS:**

(7-15-08)(Rev. 1-16-24)

108-2

SP1 G58

The Contractor's attention is directed to the Standard Special Provision entitled *Availability of Funds Termination of Contracts* included elsewhere in this proposal. The Department of Transportation's schedule of estimated completion progress for this project as required by that Standard Special Provision is as follows:

	<b><u>Fiscal Year</u></b>	<b><u>Progress (% of Dollar Value)</u></b>
2024	(7/01/23 - 6/30/24)	5% of Total Amount Bid
2025	(7/01/24 - 6/30/25)	95% of Total Amount Bid

The Contractor shall also furnish his own progress schedule in accordance with Article 108-2 of the *Standard Specifications*. Any acceleration of the progress as shown by the Contractor's progress schedule over the progress as shown above shall be subject to the approval of the Engineer.

**MINORITY BUSINESS ENTERPRISE AND WOMEN BUSINESS ENTERPRISE (DIVISIONS):**

(10-16-07)(Rev. 1-16-24)

102-15(J)

SP1 G67

**Description**

The purpose of this Special Provision is to carry out the North Carolina Department of Transportation's policy of ensuring nondiscrimination in the award and administration of contracts financed in whole or in part with State funds.

**Definitions**

*Additional MBE/WBE Subcontractors* - Any MBE/WBE submitted at the time of bid that will not be used to meet the Combined MBE/WBE goal. No submittal of a Letter of Intent is required.

*Combined MBE/WBE Goal:* A portion of the total contract, expressed as a percentage that is to be performed by committed MBE/WBE subcontractors.

*Committed MBE/WBE Subcontractor* - Any MBE/WBE submitted at the time of bid that is being used to meet the Combined MBE / WBE goal by submission of a Letter of Intent. Or any MBE or WBE used as a replacement for a previously committed MBE or WBE firm.

*Contract Goal Requirement* - The approved participation at time of award, but not greater than the advertised Combined MBE/WBE contract goal.

*Goal Confirmation Letter* - Written documentation from the Department to the bidder confirming the Contractor's approved, committed participation along with a listing of the committed MBE and WBE firms.

*Manufacturer* - A firm that operates or maintains a factory or establishment that produces on the premises, the materials or supplies obtained by the Contractor.

*MBE Participation (Anticipated)* - A portion of the total contract, expressed as a percentage that is anticipated to be performed by committed MBE subcontractor(s).

*Minority Business Enterprise (MBE)* - A firm certified as a Disadvantaged Minority-Owned Business Enterprise through the North Carolina Unified Certification Program.

*Regular Dealer* - A firm that owns, operates, or maintains a store, warehouse, or other establishment in which the materials or supplies required for the performance of the contract are bought, kept in stock, and regularly sold to the public in the usual course of business. A regular dealer engages in, as its principal business and in its own name, the purchase and sale or lease of the products in question. A regular dealer in such bulk items as steel, cement, gravel, stone, and petroleum products need not keep such products in stock, if it owns and operates distribution equipment for the products. Brokers and packagers are not regarded as manufacturers or regular dealers within the meaning of this section.

*Replacement / Substitution* – A full or partial reduction in the amount of work subcontracted to a committed (or an approved substitute) MBE/WBE firm.

*North Carolina Unified Certification Program (NCUCP)* - A program that provides comprehensive services and information to applicants for MBE/WBE certification. The MBE/WBE program follows the same regulations as the federal Disadvantaged Business Enterprise (DBE) program in accordance with 49 CFR Part 26.

*United States Department of Transportation (USDOT)* - Federal agency responsible for issuing regulations (49 CFR Part 26) and official guidance for the DBE program.

*WBE Participation (Anticipated)* - A portion of the total contract, expressed as a percentage that is anticipated to be performed by committed WBE subcontractor(s).

*Women Business Enterprise (WBE)* - A firm certified as a Disadvantaged Women-Owned Business Enterprise through the North Carolina Unified Certification Program.

### **Forms and Websites Referenced in this Provision**

*Payment Tracking System* - On-line system in which the Contractor enters the payments made to MBE and WBE subcontractors who have performed work on the project.  
<https://apps.dot.state.nc.us/Vendor/PaymentTracking/>

*DBE-IS Subcontractor Payment Information* - Form for reporting the payments made to all MBE/WBE firms working on the project. This form is for paper bid projects only.  
<https://connect.ncdot.gov/business/Turnpike/Documents/Form%20DBE-IS%20Subcontractor%20Payment%20Information.pdf>

*RF-1 MBE/WBE Replacement Request Form* - Form for replacing a committed MBE or WBE.  
<https://connect.ncdot.gov/projects/construction/Construction%20Forms/DBE%20MBE%20WBE%20Replacement%20Form%20and%20Instructions.pdf>

*SAF Subcontract Approval Form* - Form required for approval to sublet the contract.

<https://connect.ncdot.gov/projects/construction/Construction%20Forms/SAF%20Form%20-%20Subcontract%20Approval%20Form%20Revised%2004-19.xlsm>

JC-1 *Joint Check Notification Form* - Form and procedures for joint check notification. The form acts as a written joint check agreement among the parties providing full and prompt disclosure of the expected use of joint checks.

<http://connect.ncdot.gov/projects/construction/Construction%20Forms/Joint%20Check%20Notification%20Form.pdf>

*Letter of Intent* - Form signed by the Contractor and the MBE/WBE subcontractor, manufacturer or regular dealer that affirms that a portion of said contract is going to be performed by the signed MBE/WBE for the estimated amount (based on quantities and unit prices) listed at the time of bid.

<http://connect.ncdot.gov/letting/LetCentral/Letter%20of%20Intent%20to%20Perform%20as%20a%20Subcontractor.pdf>

*Listing of MBE and WBE Subcontractors Form* - Form for entering MBE/WBE subcontractors on a project that will meet the Combined MBE/WBE goal. This form is for paper bids only.

[http://connect.ncdot.gov/municipalities/Bid%20Proposals%20for%20LGA%20Content/09%20MBE-WBE%20Subcontractors%20\(State\).docx](http://connect.ncdot.gov/municipalities/Bid%20Proposals%20for%20LGA%20Content/09%20MBE-WBE%20Subcontractors%20(State).docx)

*Subcontractor Quote Comparison Sheet* - Spreadsheet for showing all subcontractor quotes in the work areas where MBEs and WBEs quoted on the project. This sheet is submitted with good faith effort packages.

<http://connect.ncdot.gov/business/SmallBusiness/Documents/DBE%20Subcontractor%20Quote%20Comparison%20Example.xls>

### **Combined MBE/WBE Goal**

The Combined MBE/WBE Goal for this project is **0.0 %**.

The Combined Goal was established utilizing the following anticipated participation for Minority Business Enterprises and Women Business Enterprises:

(A) Minority Business Enterprises **0.0 %**

- (1) *If the anticipated MBE participation is more than zero*, the Contractor shall exercise all necessary and reasonable steps to ensure that MBEs participate in at least the percent of the contract as set forth above.
- (2) *If the anticipated MBE participation is zero*, the Contractor shall make an effort to recruit and use MBEs during the performance of the contract. Any MBE participation obtained shall be reported to the Department.

(B) Women Business Enterprises **0.0 %**

- (1) *If the anticipated WBE participation is more than zero*, the Contractor shall exercise all necessary and reasonable steps to ensure that WBEs participate in at least the percent of the contract as set forth above.

- (2) *If the anticipated WBE participation is zero*, the Contractor shall make an effort to recruit and use WBEs during the performance of the contract. Any WBE participation obtained shall be reported to the Department.

The Bidder is required to submit only participation to meet the Combined MBE/WBE Goal. The Combined Goal may be met by submitting all MBE participation, all WBE participation, or a combination of MBE and WBE participation.

### **Directory of Transportation Firms (Directory)**

Real-time information is available about firms doing business with the Department and firms that are certified through NCUCP in the Directory of Transportation Firms. Only firms identified in the Directory as MBE and WBE certified shall be used to meet the Combined MBE / WBE goal. The Directory can be found at the following link.

<https://www.ebs.nc.gov/VendorDirectory/default.html>

The listing of an individual firm in the directory shall not be construed as an endorsement of the firm's capability to perform certain work.

### **Listing of MBE/WBE Subcontractors**

At the time of bid, bidders shall submit all MBE and WBE participation that they anticipate to use during the life of the contract. Only those identified to meet the Combined MBE/WBE goal will be considered committed, even though the listing shall include both committed MBE/WBE subcontractors and additional MBE/WBE subcontractors. Any additional MBE/WBE subcontractor participation above the goal will follow the banking guidelines found elsewhere in this provision. All other additional MBE/WBE subcontractor participation submitted at the time of bid will be used toward the Department's overall race-neutral goals. Only those firms with current MBE and WBE certification at the time of bid opening will be acceptable for listing in the bidder's submittal of MBE and WBE participation. The Contractor shall indicate the following required information:

#### **(A) Electronic Bids**

Bidders shall submit a listing of MBE and WBE participation in the appropriate section of the electronic submittal file.

- (1) Submit the names and addresses of MBE and WBE firms identified to participate in the contract. If the bidder uses the updated listing of MBE and WBE firms shown in the electronic submittal file, the bidder may use the dropdown menu to access the name and address of the firms.
- (2) Submit the contract line numbers of work to be performed by each MBE and WBE firm. When no figures or firms are entered, the bidder will be considered to have no MBE or WBE participation.

- (3) The bidder shall be responsible for ensuring that the MBE and WBE are certified at the time of bid by checking the Directory of Transportation Firms. If the firm is not certified at the time of the bid-letting, that MBE's or WBE's participation will not count towards achieving the Combined MBE/WBE goal.

(B) Paper Bids

- (1) *If the Combined MBE/ WBE goal is more than zero,*
  - (a) Bidders, at the time the bid proposal is submitted, shall submit a listing of MBE/WBE participation, including the names and addresses on *Listing of MBE and WBE Subcontractors* contained elsewhere in the contract documents in order for the bid to be considered responsive. Bidders shall indicate the total dollar value of the MBE and WBE participation for the contract.
  - (b) If bidders have no MBE or WBE participation, they shall indicate this on the *Listing of MBE and WBE Subcontractors* by entering the word "None" or the number "0." This form shall be completed in its entirety. **Blank forms will not be deemed to represent zero participation.** Bids submitted that do not have MBE and WBE participation indicated on the appropriate form will not be read publicly during the opening of bids. The Department will not consider these bids for award and the proposal will be rejected.
  - (c) The bidder shall be responsible for ensuring that the MBE/WBE is certified at the time of bid by checking the Directory of Transportation Firms. If the firm is not certified at the time of the bid-letting, that MBE's or WBE's participation will not count towards achieving the Combined MBE/WBE goal.
- (2) *If the Combined MBE/WBE Goal is zero,* entries on the *Listing of MBE and WBE Subcontractors* are not required for the zero goal, however any MBE or WBE participation that is achieved during the project shall be reported in accordance with requirements contained elsewhere in the special provision.

**MBE or WBE Prime Contractor**

When a certified MBE or WBE firm bids on a contract that contains a Combined MBE/WBE Goal, the firm is responsible for meeting the goal or making good faith efforts to meet the goal, just like any other bidder. In most cases, a MBE or WBE bidder on a contract will meet the Combined MBE/WBE goal by virtue of the work it performs on the contract with its own forces. However, all the work that is performed by the MBE or WBE bidder and any other similarly certified subcontractors will count toward the goal. The MBE or WBE bidder shall list itself along with any MBE or WBE subcontractors, if any, in order to receive credit toward the goals.

MBE/WBE prime contractors shall also follow Sections A or B listed under *Listing of MBE/WBE Subcontractors* just as a non-MBE/WBE bidder would.

**Written Documentation – Letter of Intent**

The bidder shall submit written documentation for each MBE/WBE that will be used to meet the Combined MBE/WBE goal of the contract, indicating the bidder's commitment to use the MBE/WBE in the contract. This documentation shall be submitted on the Department's form titled *Letter of Intent*.

The documentation shall be received in the office of the Engineer no later than 2:00 p.m. of the fifth calendar day following opening of bids, unless the fifth day falls on Saturday, Sunday or an official state holiday. In that situation, it is due in the office of the Engineer no later than 10:00 a.m. on the next official state business day.

If the bidder fails to submit the Letter of Intent from each committed MBE and WBE to be used toward the Combined MBE/WBE goal, or if the form is incomplete (i.e. both signatures are not present), the MBE/WBE participation will not count toward meeting the Combined MBE/WBE goal. If the lack of this participation drops the commitment below the Combined MBE/WBE goal, the Contractor shall submit evidence of good faith efforts for the goal not met, completed in its entirety, to the Engineer no later than 2:00 p.m. of the eighth calendar day following opening of bids, unless the eighth day falls on Saturday, Sunday or an official state holiday. In that situation, it is due in the office of the Engineer no later than 10:00 a.m. on the next official state business day.

**Banking MBE/WBE Credit**

If the committed MBE/WBE participation submitted exceeds the algebraic sum of the Combined MBE/WBE goal by \$1,000 or more, the excess will be placed on deposit by the Department for future use by the bidder. Separate accounts will be maintained for MBE and WBE participation and these may accumulate for a period not to exceed 24 months.

When the apparent lowest responsive bidder fails to submit sufficient participation by MBE and WBE firms to meet the advertised goal, as part of the good faith effort, the Department will consider allowing the bidder to withdraw funds to meet the Combined MBE/WBE goal as long as there are adequate funds available from the bidder's MBE and WBE bank accounts.

**Submission of Good Faith Effort**

If the bidder fails to meet or exceed the Combined MBE/WBE goal, the apparent lowest responsive bidder shall submit to the Department documentation of adequate good faith efforts made to reach that specific goal.

One complete set and 5 copies of this information shall be received in the office of the Engineer no later than 2:00 p.m. of the fifth calendar day following opening of bids, unless the fifth day falls on Saturday, Sunday or an official state holiday. In that situation, it is due in the office of the Engineer no later than 10:00 a.m. on the next official state business day.

Note: Where the information submitted includes repetitious solicitation letters, it will be acceptable to submit a representative letter along with a distribution list of the firms that were

solicited. Documentation of MBE/WBE quotations shall be a part of the good faith effort submittal. This documentation may include written subcontractor quotations, telephone log notations of verbal quotations, or other types of quotation documentation.

### **Consideration of Good Faith Effort for Projects with a Combined MBE/WBE Goal More Than Zero**

Adequate good faith efforts mean that the bidder took all necessary and reasonable steps to achieve the goal which, by their scope, intensity, and appropriateness, could reasonably be expected to obtain sufficient MBE/WBE participation. Adequate good faith efforts also mean that the bidder actively and aggressively sought MBE/WBE participation. Mere *pro forma* efforts are not considered good faith efforts.

The Department will consider the quality, quantity, and intensity of the different kinds of efforts a bidder has made. Listed below are examples of the types of actions a bidder will take in making a good faith effort to meet the goals and are not intended to be exclusive or exhaustive, nor is it intended to be a mandatory checklist.

- (A) Soliciting through all reasonable and available means (e.g. attendance at pre-bid meetings, advertising, written notices, use of verifiable electronic means through the use of the NCDOT Directory of Transportation Firms) the interest of all certified MBEs/WBEs that are also prequalified subcontractors. The bidder must solicit this interest within at least 10 days prior to bid opening to allow the MBEs/WBEs to respond to the solicitation. Solicitation shall provide the opportunity to MBEs/WBEs within the Division and surrounding Divisions where the project is located. The bidder must determine with certainty if the MBEs/WBEs are interested by taking appropriate steps to follow up initial solicitations.
- (B) Selecting portions of the work to be performed by MBEs/WBEs in order to increase the likelihood that the Combined MBE/WBE goal will be achieved.
  - (1) Where appropriate, break out contract work items into economically feasible units to facilitate MBE/WBE participation, even when the prime contractor might otherwise prefer to perform these work items with its own forces.
  - (2) Negotiate with subcontractors to assume part of the responsibility to meet the advertised goal when the work to be sublet includes potential for MBE/WBE participation (2<sup>nd</sup> and 3<sup>rd</sup> tier subcontractors).
- (C) Providing interested certified MBEs/WBEs that are also prequalified subcontractors with adequate information about the plans, specifications, and requirements of the contract in a timely manner to assist them in responding to a solicitation.
- (D)
  - (1) Negotiating in good faith with interested MBEs/WBEs. It is the bidder's responsibility to make a portion of the work available to MBE/WBE subcontractors and suppliers and to select those portions of the work or material needs consistent with the available MBE/WBE subcontractors and suppliers, so as to facilitate MBE/WBE participation. Evidence of such negotiation includes the names,

addresses, and telephone numbers of MBEs/WBEs that were considered; a description of the information provided regarding the plans and specifications for the work selected for subcontracting; and evidence as to why additional agreements could not be reached for MBEs/WBEs to perform the work.

- (2) A bidder using good business judgment would consider a number of factors in negotiating with subcontractors, including MBE/WBE subcontractors, and would take a firm's price and capabilities as well as the advertised goal into consideration. However, the fact that there may be some additional costs involved in finding and using MBEs/WBEs is not in itself sufficient reason for a bidder's failure to meet the advertised goal, as long as such costs are reasonable. Also, the ability or desire of a prime contractor to perform the work of a contract with its own organization does not relieve the bidder of the responsibility to make good faith efforts. Bidding contractors are not, however, required to accept higher quotes from MBEs/WBEs if the price difference is excessive or unreasonable.
- (E) Not rejecting MBEs/WBEs as being unqualified without sound reasons based on a thorough investigation of their capabilities. The bidder's standing within its industry, membership in specific groups, organizations, or associates and political or social affiliations (for example, union vs. non-union employee status) are not legitimate causes for the rejection or non-solicitation of bids in the bidder's efforts to meet the project goal.
- (F) Making efforts to assist interested MBEs/WBEs in obtaining bonding, lines of credit, or insurance as required by the recipient or bidder.
- (G) Making efforts to assist interested MBEs/WBEs in obtaining necessary equipment, supplies, materials, or related assistance or services.
- (H) Effectively using the services of available minority/women community organizations; minority/women contractors' groups; Federal, State, and local minority/women business assistance offices; and other organizations as allowed on a case-by-case basis to provide assistance in the recruitment and placement of MBEs/WBEs. Contact within 7 days from the bid opening the Business Opportunity and Work Force Development Unit at [BOWD@ncdot.gov](mailto:BOWD@ncdot.gov) to give notification of the bidder's inability to get MBE or WBE quotes.
- (I) Any other evidence that the bidder submits which shows that the bidder has made reasonable good faith efforts to meet the advertised goal.

In addition, the Department may take into account the following:

- (1) Whether the bidder's documentation reflects a clear and realistic plan for achieving the Combined MBE/WBE goal.
- (2) The bidders' past performance in meeting the contract goal.
- (3) The performance of other bidders in meeting the advertised goal. For example, when the apparent successful bidder fails to meet the goal, but others meet it, you



may reasonably raise the question of whether, with additional reasonable efforts the apparent successful bidder could have met the goal. If the apparent successful bidder fails to meet the advertised goal, but meets or exceeds the average MBE and WBE participation obtained by other bidders, the Department may view this, in conjunction with other factors, as evidence of the apparent successful bidder having made a good faith effort.

If the Department does not award the contract to the apparent lowest responsive bidder, the Department reserves the right to award the contract to the next lowest responsive bidder that can satisfy to the Department that the Combined MBE/WBE goal can be met or that an adequate good faith effort has been made to meet the advertised goal.

### **Non-Good Faith Appeal**

The Engineer will notify the contractor verbally and in writing of non-good faith. A contractor may appeal a determination of non-good faith made by the Goal Compliance Committee. If a contractor wishes to appeal the determination made by the Committee, they shall provide written notification to the Engineer. The appeal shall be made within 2 business days of notification of the determination of non-good faith.

### **Counting MBE/WBE Participation Toward Meeting the Combined MBE/WBE Goal**

#### **(A) Participation**

The total dollar value of the participation by a committed MBE/WBE will be counted toward the contract goal requirements. The total dollar value of participation by a committed MBE/WBE will be based upon the value of work actually performed by the MBE/WBE and the actual payments to MBE/WBE firms by the Contractor.

#### **(B) Joint Checks**

Prior notification of joint check use shall be required when counting MBE/WBE participation for services or purchases that involves the use of a joint check. Notification shall be through submission of Form JC-1 (*Joint Check Notification Form*) and the use of joint checks shall be in accordance with the Department's Joint Check Procedures.

#### **(C) Subcontracts (Non-Trucking)**

A MBE/WBE may enter into subcontracts. Work that a MBE subcontracts to another MBE firm may be counted toward the anticipated MBE participation. The same holds for work that a WBE subcontracts to another WBE firm. Work that a MBE/WBE subcontracts to a non-MBE/WBE firm does not count toward the contract goal requirement. It should be noted that every effort shall be made by MBE and WBE contractors to subcontract to the same certification (i.e., MBEs to MBEs and WBEs to WBEs), in order to fulfill the MBE or WBE participation breakdown. This, however, may not always be possible due to the limitation of firms in the area. If the MBE or WBE firm shows a good faith effort has been made to reach out to similarly certified firms and there is no interest or availability, and

they can get assistance from other certified firms, the Engineer will not hold the prime responsible for meeting the individual MBE or WBE breakdown. If a MBE or WBE contractor or subcontractor subcontracts a significantly greater portion of the work of the contract than would be expected on the basis of standard industry practices, it shall be presumed that the MBE or WBE is not performing a commercially useful function.

(D) Joint Venture

When a MBE or WBE performs as a participant in a joint venture, the Contractor may count toward its contract goal requirement a portion of the total value of participation with the MBE or WBE in the joint venture, that portion of the total dollar value being a distinct clearly defined portion of work that the MBE or WBE performs with its forces.

(E) Suppliers

A contractor may count toward its MBE /WBE requirement 60 percent of its expenditures for materials and supplies required to complete the contract and obtained from a MBE or WBE regular dealer and 100 percent of such expenditures from a MBE or WBE manufacturer.

(F) Manufacturers and Regular Dealers

A contractor may count toward its MBE /WBE requirement the following expenditures to MBE/WBE firms that are not manufacturers or regular dealers:

- (1) The fees or commissions charged by a MBE/WBE firm for providing a *bona fide* service, such as professional, technical, consultant, or managerial services, or for providing bonds or insurance specifically required for the performance of a DOT-assisted contract, provided the fees or commissions are determined to be reasonable and not excessive as compared with fees and commissions customarily allowed for similar services.
- (2) With respect to materials or supplies purchased from a MBE/WBE, which is neither a manufacturer nor a regular dealer, count the entire amount of fees or commissions charged for assistance in the procurement of the materials and supplies, or fees or transportation charges for the delivery of materials or supplies required on a job site (but not the cost of the materials and supplies themselves), provided the fees are determined to be reasonable and not excessive as compared with fees customarily allowed for similar services.

**Commercially Useful Function**

(A) MBE/WBE Utilization

The Contractor may count toward its contract goal requirement only expenditures to MBEs and WBEs that perform a commercially useful function in the work of a contract. A MBE/WBE performs a commercially useful function when it is responsible for execution of the work of the contract and is carrying out its responsibilities by actually

performing, managing, and supervising the work involved. To perform a commercially useful function, the MBE/WBE shall also be responsible with respect to materials and supplies used on the contract, for negotiating price, determining quality and quantity, ordering the material and installing (where applicable) and paying for the material itself. To determine whether a MBE/WBE is performing a commercially useful function, the Department will evaluate the amount of work subcontracted, industry practices, whether the amount the firm is to be paid under the contract is commensurate with the work it is actually performing and the MBE/WBE credit claimed for its performance of the work, and any other relevant factors. If it is determined that a MBE or WBE is not performing a Commercially Useful Function, the contractor may present evidence to rebut this presumption to the Department.

(B) MBE/WBE Utilization in Trucking

The following factors will be used to determine if a MBE or WBE trucking firm is performing a commercially useful function:

- (1) The MBE/WBE shall be responsible for the management and supervision of the entire trucking operation for which it is responsible on a particular contract, and there shall not be a contrived arrangement for the purpose of meeting the Combined MBE/WBE goal.
- (2) The MBE/WBE shall itself own and operate at least one fully licensed, insured, and operational truck used on the contract.
- (3) The MBE/WBE receives credit for the total value of the transportation services it provides on the contract using trucks it owns, insures, and operates using drivers it employs.
- (4) The MBE may subcontract the work to another MBE firm, including an owner-operator who is certified as a MBE. The same holds true that a WBE may subcontract the work to another WBE firm, including an owner-operator who is certified as a WBE. When this occurs, the MBE or WBE who subcontracts work receives credit for the total value of the transportation services the subcontracted MBE or WBE provides on the contract. It should be noted that every effort shall be made by MBE and WBE contractors to subcontract to the same certification (i.e., MBEs to MBEs and WBEs to WBEs), in order to fulfill the participation breakdown. This, however, may not always be possible due to the limitation of firms in the area. If the MBE or WBE firm shows a good faith effort has been made to reach out to similarly certified transportation service providers and there is no interest or availability, and they can get assistance from other certified providers, the Engineer will not hold the prime responsible for meeting the individual MBE or WBE participation breakdown.
- (5) The MBE/WBE may also subcontract the work to a non-MBE/WBE firm, including from an owner-operator. The MBE/WBE who subcontracts the work to a non-MBE/WBE is entitled to credit for the total value of transportation services provided by the non-MBE/WBE subcontractor not to exceed the value

of transportation services provided by MBE/WBE-owned trucks on the contract. Additional participation by non-MBE/WBE subcontractors receives credit only for the fee or commission it receives as a result of the subcontract arrangement. The value of services performed under subcontract agreements between the MBE/WBE and the Contractor will not count towards the MBE/WBE contract requirement.

- (6) A MBE/WBE may lease truck(s) from an established equipment leasing business open to the general public. The lease must indicate that the MBE/WBE has exclusive use of and control over the truck. This requirement does not preclude the leased truck from working for others during the term of the lease with the consent of the MBE/WBE, so long as the lease gives the MBE/WBE absolute priority for use of the leased truck. This type of lease may count toward the MBE/WBE's credit as long as the driver is under the MBE/WBE's payroll.
- (7) Subcontracted/leased trucks shall display clearly on the dashboard the name of the MBE/WBE that they are subcontracted/leased to and their own company name if it is not identified on the truck itself. Magnetic door signs are not permitted.

### **MBE/WBE Replacement**

When a Contractor has relied on a commitment to a MBE or WBE subcontractor (or an approved substitute MBE or WBE subcontractor) to meet all or part of a contract goal requirement, the contractor shall not terminate the MBE/WBE subcontractor for convenience. This includes, but is not limited to, instances in which the Contractor seeks to perform the work of the terminated subcontractor with another MBE/WBE subcontractor, a non-MBE/WBE subcontractor, or with the Contractor's own forces or those of an affiliate.

The Contractor must give notice in writing both by certified mail and email to the MBE/WBE subcontractor, with a copy to the Engineer of its intent to request to terminate and/or substitute, and the reason for the request. The Contractor must give the MBE/WBE subcontractor five (5) business days to respond to the Contractor's Notice of Intent to Request Termination and/or Substitution. If the MBE/WBE subcontractor objects to the intended termination/substitution, the MBE/WBE, within five (5) business days must advise the Contractor and the Department of the reasons why the action should not be approved. The five-day notice period shall begin on the next business day after written notice is provided to the MBE/WBE subcontractor.

A committed MBE/WBE subcontractor may only be terminated after receiving the Department's written approval based upon a finding of good cause for the proposed termination and/or substitution. For purposes of this section, good cause shall include the following circumstances:

- (a) The listed MBE/WBE subcontractor fails or refuses to execute a written contract;
- (b) The listed MBE/WBE subcontractor fails or refuses to perform the work of its subcontract in a way consistent with normal industry standards. Provided, however, that good cause does not exist if the failure or refusal of the MBE/WBE subcontractor to perform its work on the subcontract results from the bad faith or discriminatory action of the prime contractor;
- (c) The listed MBE/WBE subcontractor fails or refuses to meet the prime contractor's reasonable, nondiscriminatory bond requirements;

- (d) The listed MBE/WBE subcontractor becomes bankrupt, insolvent, or exhibits credit unworthiness;
- (e) The listed MBE/WBE subcontractor is ineligible to work on public works projects because of suspension and debarment proceedings pursuant to 2 CFR Parts 180, 215 and 1,200 or applicable state law;
- (f) The listed MBE/WBE subcontractor is not a responsible contractor;
- (g) The listed MBE/WBE voluntarily withdraws from the project and provides written notice of withdrawal;
- (h) The listed MBE/WBE is ineligible to receive MBE/WBE credit for the type of work required;
- (i) A MBE/WBE owner dies or becomes disabled with the result that the listed MBE/WBE contractor is unable to complete its work on the contract;
- (j) Other documented good cause that compels the termination of the MBE/WBE subcontractor. Provided, that good cause does not exist if the prime contractor seeks to terminate a MBE/WBE it relied upon to obtain the contract so that the prime contractor can self-perform the work for which the MBE/WBE contractor was engaged or so that the prime contractor can substitute another MBE/WBE or non-MBE/WBE contractor after contract award.

The Contractor shall comply with the following for replacement of a committed MBE/WBE:

(A) Performance Related Replacement

When a committed MBE/WBE is terminated for good cause as stated above, an additional MBE/WBE that was submitted at the time of bid may be used to fulfill the MBE/WBE commitment to meet the Combined MBE/WBE Goal. A good faith effort will only be required for removing a committed MBE/WBE if there were no additional MBE/WBEs submitted at the time of bid to cover the same amount of work as the MBE/WBE that was terminated.

If a replacement MBE/WBE is not found that can perform at least the same amount of work as the terminated MBE/WBE, the Contractor shall submit a good faith effort documenting the steps taken. Such documentation shall include, but not be limited to, the following:

- (1) Copies of written notification to MBE/WBEs that their interest is solicited in contracting the work defaulted by the previous MBE/WBE or in subcontracting other items of work in the contract.
- (2) Efforts to negotiate with MBE/WBEs for specific subbids including, at a minimum:
  - (a) The names, addresses, and telephone numbers of MBE/WBEs who were contacted.
  - (b) A description of the information provided to MBE/WBEs regarding the plans and specifications for portions of the work to be performed.
- (3) A list of reasons why MBE/WBE quotes were not accepted.

- (4) Efforts made to assist the MBE/WBEs contacted, if needed, in obtaining bonding or insurance required by the Contractor.
- (B) Decertification Replacement
- (1) When a committed MBE/WBE is decertified by the Department after the SAF (*Subcontract Approval Form*) has been received by the Department, the Department will not require the Contractor to solicit replacement MBE/WBE participation equal to the remaining work to be performed by the decertified firm. The participation equal to the remaining work performed by the decertified firm will count toward the contract goal requirement.
  - (2) When a committed MBE/WBE is decertified prior to the Department receiving the SAF (*Subcontract Approval Form*) for the named MBE/WBE firm, the Contractor shall take all necessary and reasonable steps to replace the MBE/WBE subcontractor with another MBE/WBE subcontractor to perform at least the same amount of work to meet the Combined MBE/WBE goal requirement. If a MBE/WBE firm is not found to do the same amount of work, a good faith effort must be submitted to NCDOT (see A herein for required documentation).
  - (3) Exception: If the MBE/WBE's ineligibility is caused solely by its having exceeded the size standard during the performance of the contract, the Department will not require the Contractor to solicit replacement MBE/WBE participation equal to the remaining work to be performed by the decertified firm. The participation equal to the remaining work performed by the decertified firm will count toward the contract goal requirement and overall goal.

All requests for replacement of a committed MBE/WBE firm shall be submitted to the Engineer for approval on Form RF-1 (*DBE Replacement Request*). If the Contractor fails to follow this procedure, the Contractor may be disqualified from further bidding for a period of up to 6 months.

### **Changes in the Work**

When the Engineer makes changes that result in the reduction or elimination of work to be performed by a committed MBE/WBE, the Contractor will not be required to seek additional participation. When the Engineer makes changes that result in additional work to be performed by a MBE/WBE based upon the Contractor's commitment, the MBE/WBE shall participate in additional work to the same extent as the MBE/WBE participated in the original contract work.

When the Engineer makes changes that result in extra work, which has more than a minimal impact on the contract amount, the Contractor shall seek additional participation by MBEs/WBEs unless otherwise approved by the Engineer.

When the Engineer makes changes that result in an alteration of plans or details of construction, and a portion or all of the work had been expected to be performed by a committed MBE/WBE, the Contractor shall seek participation by MBEs/WBEs unless otherwise approved by the Engineer.

When the Contractor requests changes in the work that result in the reduction or elimination of work that the Contractor committed to be performed by a MBE/WBE, the Contractor shall seek additional participation by MBEs/WBEs equal to the reduced MBE/WBE participation caused by the changes.

### **Reports and Documentation**

A SAF (*Subcontract Approval Form*) shall be submitted for all work which is to be performed by a MBE/WBE subcontractor. The Department reserves the right to require copies of actual subcontract agreements involving MBE/WBE subcontractors.

When using transportation services to meet the contract commitment, the Contractor shall submit a proposed trucking plan in addition to the SAF. The plan shall be submitted prior to beginning construction on the project. The plan shall include the names of all trucking firms proposed for use, their certification type(s), the number of trucks owned by the firm, as well as the individual truck identification numbers, and the line item(s) being performed.

Within 30 calendar days of entering into an agreement with a MBE/WBE for materials, supplies or services, not otherwise documented by the SAF as specified above, the Contractor shall furnish the Engineer a copy of the agreement. The documentation shall also indicate the percentage (60% or 100%) of expenditures claimed for MBE/WBE credit.

### **Reporting Minority and Women Business Enterprise Participation**

The Contractor shall provide the Engineer with an accounting of payments made to all MBE and WBE firms, including material suppliers and contractors at all levels (prime, subcontractor, or second tier subcontractor). This accounting shall be furnished to the Engineer for any given month by the end of the following month. Failure to submit this information accordingly may result in the following action:

- (A) Withholding of money due in the next partial pay estimate; or
- (B) Removal of an approved contractor from the prequalified bidders' list or the removal of other entities from the approved subcontractors list.

While each contractor (prime, subcontractor, 2nd tier subcontractor) is responsible for accurate accounting of payments to MBEs/WBEs, it shall be the prime contractor's responsibility to report all monthly and final payment information in the correct reporting manner.

Failure on the part of the Contractor to submit the required information in the time frame specified may result in the disqualification of that contractor and any affiliate companies from further bidding until the required information is submitted.

Failure on the part of any subcontractor to submit the required information in the time frame specified may result in the disqualification of that contractor and any affiliate companies from being approved for further work on future projects until the required information is submitted.

Contractors reporting transportation services provided by non-MBE/WBE lessees shall evaluate the value of services provided during the month of the reporting period only.

At any time, the Engineer can request written verification of subcontractor payments. The Contractor shall report the accounting of payments through the Department's DBE Payment Tracking System.

### **Failure to Meet Contract Requirements**

Failure to meet contract requirements in accordance with Subarticle 102-15(J) of the *Standard Specifications* may be cause to disqualify the Contractor.

### **RESTRICTIONS ON ITS EQUIPMENT AND SERVICES:**

(11-17-20)

SP01 G090

All telecommunications, video or other ITS equipment or services installed or utilized on this project must be in conformance with UNIFORM ADMINISTRATIVE REQUIREMENTS, COST PRINCIPLES, AND AUDIT REQUIREMENTS FOR FEDERAL AWARDS **2 CFR, § 200.216**  
**Prohibition on certain telecommunications and video surveillance services or equipment.**

### **USE OF UNMANNED AIRCRAFT SYSTEM (UAS):**

(8-20-19)

SP1 G092

The Contractor shall adhere to all Federal, State and Local regulations and guidelines for the use of Unmanned Aircraft Systems (UAS). This includes but is not limited to US 14 CFR Part 107 *Small UAS Rule*, NC GS 15A-300.2 *Regulation of launch and recovery sites*, NC GS 63-95 *Training required for the operation of unmanned aircraft systems*, NC GS 63-96 *Permit required for commercial operation of unmanned aircraft system*, and NCDOT UAS Policy. The required operator certifications include possessing a current Federal Aviation Administration (FAA) Remote Pilot Certificate, a NC UAS Operator Permit as well as operating a UAS registered with the FAA.

Prior to beginning operations, the Contractor shall complete the NCDOT UAS – Flight Operation Approval Form and submit it to the Engineer for approval. All UAS operations shall be approved by the Engineer prior to beginning the operations.

All contractors or subcontractors operating UAS shall have UAS specific general liability insurance to cover all operations under this contract.

The use of UAS is at the Contractor's discretion. No measurement or payment will be made for the use of UAS. In the event that the Department directs the Contractor to utilize UAS, payment will be in accordance with Article 104-7 Extra Work.



**EQUIPMENT IDLING GUIDELINES:**

(1-19-21)

107

SP1 G096

Exercise reduced fuel consumption and reduced equipment emissions during the construction of all work associated with this contract. Employees engaged in the construction of this project should turn off vehicles when stopped for more than thirty (30) minutes and off-highway equipment should idle no longer than fifteen (15) consecutive minutes.

These guidelines for turning off vehicles and equipment when idling do not apply to:

1. Idling when queuing.
2. Idling to verify the vehicle is in safe operating condition.
3. Idling for testing, servicing, repairing or diagnostic purposes.
4. Idling necessary to accomplish work for which the vehicle was designed (such as operating a crane, mixing concrete, etc.).
5. Idling required to bring the machine system to operating temperature.
6. Emergency vehicles, utility company, construction, and maintenance vehicles where the engines must run to perform needed work.
7. Idling to ensure safe operation of the vehicle.
8. Idling when the propulsion engine is providing auxiliary power for other than heating or air conditioning. (such as hydraulic systems for pavers)
9. When specific traffic, safety, or emergency situations arise.
10. If the ambient temperature is less than 32 degrees Fahrenheit. Limited idling to provide for the safety of vehicle occupants (e.g. to run the heater).
11. If the ambient temperature is greater than 90 degrees Fahrenheit. Limited idling to provide for the safety of vehicle occupants of off-highway equipment (e.g. to run the air conditioning) no more than 30 minutes.
12. Diesel powered vehicles may idle for up to 30 minutes to minimize restart problems.

Any vehicle, truck, or equipment in which the primary source of fuel is natural gas or electricity is exempt from the idling limitations set forth in this special provision.

**OUTSOURCING OUTSIDE THE USA:**

(9-21-04) (Rev. 5-16-06)

SP1 G150

All work on consultant contracts, services contracts, and construction contracts shall be performed in the United States of America. No work shall be outsourced outside of the United States of America.

*Outsourcing* for the purpose of this provision is defined as the practice of subcontracting labor, work, services, staffing, or personnel to entities located outside of the United States.

The North Carolina Secretary of Transportation shall approve exceptions to this provision in writing.

**PROCEDURE FOR MONITORING BORROW PIT DISCHARGE:**

(2-20-07) (Rev. 1-16-24)

105-16, 230, 801

SP1 G181

Water discharge from borrow pit sites shall not cause surface waters to exceed 50 NTUs (nephelometric turbidity unit) in streams not designated as trout waters and 10 NTUs in streams, lakes or reservoirs designated as trout waters. For lakes and reservoirs not designated as trout waters, the turbidity shall not exceed 25 NTUs. If the turbidity exceeds these levels due to natural background conditions, the existing turbidity level shall not be increased.

If during any operating day, the downstream water quality exceeds the standard, the Contractor shall do all of the following:

- (A) Either cease discharge or modify the discharge volume or turbidity levels to bring the downstream turbidity levels into compliance, or
- (B) Evaluate the upstream conditions to determine if the exceedance of the standard is due to natural background conditions. If the background turbidity measurements exceed the standard, operation of the pit and discharge can continue as long as the stream turbidity levels are not increased due to the discharge.
- (C) Measure and record the turbidity test results (time, date and sampler) at all defined sampling locations 30 minutes after startup and at a minimum, one additional sampling of all sampling locations during that 24-hour period in which the borrow pit is discharging.
- (D) Notify DWQ within 24 hours of any stream turbidity standard exceedances that are not brought into compliance.

During the Environmental Assessment required by Article 230-4 of the *Standard Specifications*, the Contractor shall define the point at which the discharge enters into the State's surface waters and the appropriate sampling locations. Sampling locations shall include points upstream and downstream from the point at which the discharge enters these waters. Upstream sampling location shall be located so that it is not influenced by backwater conditions and represents natural background conditions. Downstream sampling location shall be located at the point where complete mixing of the discharge and receiving water has occurred.

The discharge shall be closely monitored when water from the dewatering activities is introduced into jurisdictional wetlands. Any time visible sedimentation (deposition of sediment) on the wetland surface is observed, the dewatering activity will be suspended until turbidity levels in the stilling basin can be reduced to a level where sediment deposition does not occur. Staining of wetland surfaces from suspended clay particles, occurring after evaporation or infiltration, does not constitute sedimentation. No activities shall occur in wetlands that adversely affect the functioning of a wetland. Visible sedimentation will be considered an indication of possible adverse impacts on wetland use.

The Engineer will perform independent turbidity tests on a random basis. These results will be maintained in a log within the project records. Records will include, at a minimum, turbidity test results, time, date and name of sampler. Should the Department's test results exceed those of the Contractor's test results, an immediate test shall be performed jointly with the results superseding the previous test results of both the Department and the Contractor.

The Contractor shall use the *NCDOT Turbidity Reduction Options for Borrow Pits Matrix*, available at <https://connect.ncdot.gov/resources/roadside/FieldOperationsDocuments/TurbidityReductionOptionSheet.pdf> to plan, design, construct, and maintain BMPs to address water quality standards. Tier I Methods include stilling basins which are standard compensatory BMPs. Other Tier I methods are noncompensatory and shall be used when needed to meet the stream turbidity standards. Tier II Methods are also noncompensatory and are options that may be needed for protection of rare or unique resources or where special environmental conditions exist at the site which have led to additional requirements being placed in the DWQ's 401 Certifications and approval letters, Isolated Wetland Permits, Riparian Buffer Authorization or a DOT Reclamation Plan's Environmental Assessment for the specific site. Should the Contractor exhaust all Tier I Methods on a site exclusive of rare or unique resources or special environmental conditions, Tier II Methods may be required by regulators on a case by case basis per supplemental agreement.

The Contractor may use cation exchange capacity (CEC) values from proposed site borings to plan and develop the bid for the project. CEC values exceeding 15 milliequivalents per 100 grams of soil may indicate a high potential for turbidity and should be avoided when dewatering into surface water is proposed.

No additional compensation for monitoring borrow pit discharge will be paid.

#### **NOTIFICATION OF OPERATIONS:**

The Contractor shall notify the Engineer 48 hours in advance of beginning work on this project. The Contractor shall give the Engineer sufficient notice of all operations for any sampling, inspection or acceptance testing required.

#### **PROGRESS AND PROSECUTION:**

The Contractor shall pursue the work diligently with workmen in sufficient numbers, abilities, and supervision, and with equipment, materials, and methods of construction as may be required to complete the work described in the contract by the completion date and in accordance with Section 108 of the *2024 Standard Specifications*.

Work may be required outside of normal weekday hours, which may include nights and weekends. There will be no additional compensation for bid items for work performed outside of normal weekday hours (9:00 PM-6:00 AM Monday through Sunday and 6:00 AM through 9:00 PM Saturday and Sunday). Work shall only be performed when weather and visibility conditions allow safe operations.

#### **UTILITY CONFLICTS:**

It shall be the responsibility of the Contractor to contact all affected utility owners and determine the precise locations of all utilities prior to beginning construction. Utility owners shall be contacted a minimum of 72 hours prior to the commencement of operations.

Special care shall be used in working around or near existing utilities, protecting them when necessary to provide uninterrupted service. In the event that any utility service is interrupted, the Contractor shall notify the utility owner immediately and shall cooperate with the owner, or his representative, in the restoration of service in the shortest time possible. Existing fire hydrants shall be kept accessible to fire departments at all times.

The Contractor shall adhere to all applicable regulations and follow accepted safety procedures when working in the vicinity of utilities in order to ensure the safety of construction personnel and the public.

**WORK SITE CLEANUP:**

The Contractor shall clean the work sites of all debris, excess excavations, waste packing material, scraps, etc. At the end of each workday the site shall be clear and clean. The Contractor shall not throw any waste material in any storm sewers or streams. All disturbed areas of vegetation shall be graded, seeded and mulched as required in the *2024 Standard Specifications*. The Contractor shall be responsible for damage to private and/or public property resulting from the work.

**PAYMENT AND RETAINAGE:**

The Contractor may submit requests for partial payments on a monthly basis, or other interval as approved by the Engineer. Compensation for all pay items shall be in accordance with the *2024 Standard Specifications*. The amount of partial payments will be based on the work accomplished and accepted by the last day of the approved pay period.

Requests for payment shall be made by Contractor's Invoice. All invoice items and unit costs shall correspond to contract pay items. In the event of error or discrepancy in items or unit costs, the Department may return the invoice to the contractor for correction. The invoice shall be completely and legibly filled out with all appropriate information and shall be signed by an authorized representative of the Contractor.

All requests for payment shall be submitted as follows:

**Toll Roads**

**Triangle Expressway Maintenance Engineer  
1301 Blue Ridge Road  
Raleigh, NC 27606**

**Non-Toll Roads**

**NCDOT Division 5  
Assistant Division Maintenance Engineer  
2612 North Duke Street  
Durham, NC 27704**

**TOLL FACILITY REIMBURSEMENT:**

The Contractor, as directed by the Engineer, may have to perform miscellaneous concrete work on toll facilities. The Contractor will be responsible for paying applicable tolls. The Department will **not** directly reimburse the Contractor for tolls paid during performance of the Misc. Concrete Work as the cost of same will be considered incidental to the work being paid for under those various item(s) that have been included.

**TOLL TRAFFIC COORDINATION:**

The Contractor shall notify the NCTA and the Traffic Management Center (TMC) at least 24 hours in advance of any traffic control installation or clean-up activities. The TMC can be notified by phone at 919-825-2611, or by email at [ncta\\_tmc@ncdot.gov](mailto:ncta_tmc@ncdot.gov). The Contractor shall also contact the TMC with any updates or changes to traffic control during activities, including completion of work. The Contractor shall also keep the Turnpike Maintenance Supervisor notified at all activities on the toll facilities. The Turnpike Maintenance Supervisor can be reached at 919-524-3275.

**PROJECT SPECIAL PROVISIONS****ROADWAY****BURNING RESTRICTIONS:**

(7-1-95)

200, 210, 215

SP2 R05

Open burning is not permitted on any portion of the right-of-way limits established for this project. Do not burn the clearing, grubbing or demolition debris designated for disposal and generated from the project at locations within the project limits, off the project limits or at any waste or borrow sites in this county. Dispose of the clearing, grubbing and demolition debris by means other than burning, according to state or local rules and regulations.

**INSPECTION:**

All work shall be subject to inspection by the engineer at any time. Routinely, the engineer will make periodic inspections of the completed work. It will be the responsibility of the contractor to keep the engineer informed of his proposed work plan and submit written reports of work accomplished on a frequency to be determined by the engineer.

**EMERGENCY MOBILIZATION FOR ID/IQ:**

(2-15-22)

SPD 01-830

The Contractor shall arrive on site within **six (6)** hours of notification. Compensation will be in addition to the specific line items in the contract. *Emergency Mobilization* will be paid for at the contract unit price per each. Failure to respond within the time frame will result in nonpayment of this item.

Payment will be made under:

**Pay Item**

Emergency Mobilization

**Pay Unit**

Each

**PIPE INSTALLATION:**

(Div 5)

300

Revise the *2024 Standard Specifications* as follows:

**Page 3-1, Article 300-1 General**, add the following paragraphs after line 9:

A trench box will be required whenever total excavation depth exceeds four (4) feet. Excessive excavation that includes laying back slopes will not be allowed without the Engineer's approval.

Pipe installation and pavement repair shall be performed in accordance with the following plan sheets in this contract unless otherwise noted: Maintenance Contract Pipe Installation and Roadway Standard Drawing 654.01 for Pavement Repairs.

**FLOWABLE FILL:**

(9-17-02) (Rev. 1-16-24)

300, 340, 1000, 1530, 1540, 1550

SP3 R30

**Description**

This work consists of all work necessary to place flowable fill in accordance with these provisions, the plans, and as directed.

**Materials**

Refer to Division 10 of the *Standard Specifications*.

**Item**

Flowable Fill

**Section**

1000-7

**Construction Methods**

Discharge flowable fill material directly from the truck into the space to be filled, or by other approved methods. The mix may be placed full depth or in lifts as site conditions dictate. The Contractor shall provide a method to plug the ends of the existing pipe in order to contain the flowable fill.

**Measurement and Payment**

At locations where flowable fill is called for on the plans and a pay item for flowable fill is included in the contract, *Flowable Fill* will be measured in cubic yards and paid as the actual number of cubic yards that have been satisfactorily placed and accepted. Such price and payment will be full compensation for all work covered by this provision including, but not limited to, the mix design, furnishing, hauling, placing and containing the flowable fill.

Payment will be made under:

**Pay Item**

Flowable Fill

**Pay Unit**

Cubic Yard

**PATCHING EXISTING PAVEMENT:**

(1-15-02) (Rev. 1-16-24)

610

SP6 R88R

**Description**

The Contractor's attention is directed to the fact that there are areas of existing pavement on this project that will require repair prior to resurfacing. Patch the areas that, in the opinion of the Engineer, need repairing. The areas to be patched will be delineated by the Engineer prior to the Contractor performing repairs.

**Materials**

The patching consists of Asphalt Concrete Base Course, Asphalt Concrete Intermediate Course, Asphalt Concrete Surface Course, or a combination of base, intermediate and surface course.

### **Construction Methods**

Remove existing pavement at locations directed by the Engineer in accordance with Section 250 of the *Standard Specifications*.

Place Asphalt Concrete Base Course in lifts not exceeding 5.5 inches. Utilize compaction equipment suitable for compacting patches as small as 3.5 feet by 6 feet on each lift. Use an approved compaction pattern to achieve proper compaction. If patched pavement is to be open to traffic between December through March of the following year, use Asphalt Concrete Intermediate Course or Asphalt Concrete Surface Course as the top layer of the patch.

Schedule operations so that all areas where pavement has been removed will be repaired on the same day of the pavement removal and all lanes of traffic restored.

### **Measurement and Payment**

*Patching Existing Pavement* will be measured and paid as the actual number of tons of asphalt plant mix complete in place that has been used to make completed and accepted repairs. The asphalt plant mixed material will be measured by being weighed in trucks on certified platform scales or other certified weighing devices. The above price and payment will be full compensation for all work covered by this provision, including but not limited to removal and disposal of all types of pavements; furnishing and applying tack coat; furnishing, placing, and compacting of asphalt plant mix; and furnishing scales.

Furnishing asphalt binder will be paid as provided herein.

Payment will be made under:

<b>Pay Item</b>	<b>Pay Unit</b>
Patching Existing Pavement	Ton

### **MINOR WIDENING:**

(3-15-11) (Division 5)

### **Description**

The contractor's attention is directed to the fact that there are areas of existing pavement on this project that will require minor widening in addition to miscellaneous concrete work. The areas to be widened will be delineated by the Engineer prior to the contractor performing widening.

### **Materials**



The widening consists of Asphalt Concrete Base course, Asphalt Concrete Intermediate Course, Asphalt Concrete Surface Course, or a combination of base, binder and surface course.

### **Construction Methods**

Perform all trenching necessary to place the asphalt widening as directed by the Engineer.

Perform the trenching on the same day that the asphalt widening is to be placed. If the widening cannot be placed on the same day the trench section is excavated, backfill the trench with earth material and compact it to the satisfaction of the Engineer. Once the trench is open, perform backfilling and re-opening of the trench at no cost to the Department.

The contractor will be restricted to widening one side of the project at a time unless otherwise permitted by the Engineer. In widening, operate equipment and conduct operations in the same direction as the flow of traffic.

Density tests may be taken every 2000 feet in the widened areas as directed by the Engineer. Shape and compact the subgrade in the widened areas to the satisfaction of the Engineer. Compact the asphalt in the widened areas in accordance with the provisions of Article 610-9 of the *2024 Standard Specifications*.

Place the excavated material from trenching operation on the adjacent shoulder area as directed by the Engineer. Cut adequate weep holes on the excavated material to provide for adequate drainage as directed by the Engineer. Remove all excavated material from all drives to provide ingress and egress to abutting properties and from in front of all mailboxes and paper boxes. Saw a neat edge and remove all asphalt and/or concrete driveways, and existing asphalt widening, as directed by the Engineer, to the width of the widening and dispose of any excavated concrete or asphalt materials. Properly reconnect driveways.

Upon completion of paving operation, backfill the trench to the satisfaction of the Engineer. Properly dispose of any excess material remaining after this operation.

### **Measurement and Payment**

*Minor Widening* will be measured and paid for as the actual number of tons of asphalt plant mix complete in place that has been used to perform the accepted widening. That asphalt plant mix material will be measured by weight in trucks in certified platform scales or other certified weighing devices. The above price and payment will be full compensation for all work covered by this provision, including but not limited to, removal and disposal of pavement and earth material; furnishing and applying tack coat; furnishing, placing and compacting of asphalt plant mix; furnishing asphalt binder for the asphalt mix and furnishing scales.

*Minor Widening* will be considered a minor item. Any provisions included in the contract that provide for adjustments in compensation due to variations in the price of asphalt binder will not be applicable to payment for work covered by this provision.

Payment will be made under:

**Pay Item**

Minor Widening

**Pay Unit**

Ton

**PRICE ADJUSTMENT PROCEDURES ASPHALT BINDER FOR PLANT MIX:**

(1-8-24) (Division 5)

Article 620 of the *2024 Standard Specifications* states that adjustments will be made to payments due the Contractor for each grade of asphalt binder when it has been determined that the monthly average terminal F.O.B. Selling Price of asphalt binder, has fluctuated from the Base Price Index for Asphalt Binder included in the Project Special Provisions.

The contract bid prices for asphalt will be adjusted **monthly** based on the monthly average Terminal FOB Selling Price as listed on

<https://connect.ncdot.gov/projects/construction/Lists/Monthly%20Terminal%20Asphalt%20Binder%20Fuel%20FOB%20Prices/AllItems.aspx>

The base price index for asphalt binder for plant mix is **\$593.75** per ton.

This base price index represents an average of F.O.B. selling prices of asphalt binder at supplier's terminals on **April 1, 2024**.

The asphalt prices in this contract will be adjusted based on the formula given below.

The following generic assumptions will be used:

All S 9.5 mixes contain 6.5% liquid AC

All I 19.0 mixes contain 4.8% liquid AC

All B 25.0 mixes contain 4.5% liquid AC

The assumptions above are for contract price calculations only. All mixes must have an approved JMF to be used on NCDOT projects. The actual liquid content of the mixes will not be used in determining price adjustments.

**Example:**

<i>Contract Base Price for Liquid</i>	<i>\$581.07/ ton</i>
<i>Contract Bid Price for S 9.5B</i>	<i>\$ 50.00 / ton</i>
<i>Liquid AC in S 9.5B</i>	<i>6.5%</i>
<i>2000 lbs./ton x 0.065</i>	<i>130 lbs. of liquid AC per ton of asphalt</i>
<i>130 lbs. liquid / 2000 lbs./ton</i>	<i>0.065 ton of liquid AC</i>
<i>\$581.07/ ton x 0.065 ton</i>	<i>\$ 37.77 liquid cost per ton of asphalt</i>
<i>\$ 50.00 bid price/ton - \$ 37.77</i>	<i>\$ 12.23 / ton – stone, labor, equip, overhead cost per ton of Asphalt</i>

***Current liquid price at time of adjustment***

***\$592.00/ton***

$\$592.00 - \$581.07$  $\$10.93$  difference $\$10.93 / \$581.07$  $0.019 = 1.9\%$  increase

Liquid price increase

 $\$37.77 \times 0.019 = \$0.72$  $\$37.77 + \$0.72 = \$38.49$  / ton liquid cost  
per ton of asphalt**Asphalt price increase, price for S 9.5B line item in contract** $\$38.49$  (new liquid) +  $\$12.23$  (stone, labor,  
etc.) $\$50.72$  / ton

So the new price per ton for S 9.5B on the contract will be  $\$50.72$ /ton for the month.

All prices for asphalt items in this contract will be adjusted **monthly** by this procedure.

**HIGH STRENGTH CONCRETE FOR CURB AND GUTTER AND DRIVEWAYS:**

(11-21-00) (Rev. 1-16-24)

848

SP10 R02

Use high early strength concrete for all driveways and curb and gutter shown in the plans and as directed by the Engineer. Provide high early strength concrete that meets the requirements of Article 1000-6 of the *Standard Specifications*.

Measurement and payment will be in accordance with Section 848 of the *Standard Specifications*.

**CONCRETE APRON FOR EXISTING STRUCTURES:**

At locations directed by the Engineer, construct aprons for existing drainage structures, in accordance with the applicable requirements of Section 840 of the *Standard Specifications*.

*Concrete Apron for Existing Drop Inlet or Catch Basin* will be measured and paid for as each, completed and accepted. Such price and payment are considered full compensation for all equipment, materials, labor, tools, and incidentals necessary to complete each apron satisfactorily.

Payment will be made under:

**Pay Item**

Concrete Apron for Existing Drop Inlet or Catch Basin

**Pay Unit**

Each

**CONCRETE TOP SLAB (LID):****Description**

This work consists of all work necessary to replace open throat drop inlet lids in accordance with these Provisions, Sections 425 and 825 of the *2024 Standard Specifications* and as directed by the Engineer.

Disposal of existing concrete slab shall be incidental to - *Concrete Top Slab*

**Materials**

Refer to Division 10 of the *2024 Standard Specifications*.

**Measurement and Payment**

*Concrete Top Slab* will be measured and paid as square foot, for the actual number incorporated into the completed and accepted work. Such price and payment will be full compensation for removal of existing slab, all materials, labor, equipment and other incidentals necessary to complete the work.

Payment will be made under:

**Pay Item**

Concrete Top Slab (Lid)

**Pay Unit**

Square Foot

**MODIFIED CONCRETE MEDIAN APRON:**

(Division 5)

825

At locations shown in the plans, construct concrete median apron in accordance with the details in the plans. Use materials meeting the requirements of Section 825 of the *Standard Specifications* except that the concrete must be Class B or of higher compressive strength.

Each concrete median apron completed and accepted will be paid at the contract unit price per square yard for *Modified Concrete Median Apron*. Such price and payment will be full compensation for all materials, labor, equipment, tools, removing and disposing of any existing aprons and other incidentals necessary to complete the work satisfactorily.

Payment will be made under:

**Pay Item**

Modified Concrete Median Apron

**Pay Unit**

Square Yard

**REMOVE AND REPLACE CONCRETE APRON FOR DROP INLET:**

Construct concrete aprons for drop inlets in accordance with this provision, *2024 Roadway Standard Drawings* 840.17, 840.18, and 840.19, and section 840 of the *2024 Standard Specifications*, at locations as directed by the Engineer. Payment for the work shall be made on a per each basis completed and accepted by the Engineer. The cost for removal and disposal of the existing drop inlet apron shall be considered incidental to the work and shall be included in the cost of the new apron.

Payment will be made under:

**Pay Item**

Remove &amp; Replace Concrete Apron for Drop Inlet

**Pay Unit**

Each

**MODIFIED CONCRETE FLUME WITH CONCRETE OUTLET:**

(3-19-96)(Rev. 1-16-24)

825

SP8 R10

At locations shown in the plans, construct concrete flumes, concrete curb, and apron in accordance with the details in the plans. Use materials meeting the requirements of Section 825 of the *Standard Specifications* except that the concrete must be Class B or of higher compressive strength.

Each concrete flume, concrete curb, and apron completed and accepted will be paid at the contract unit price per each for *Modified Concrete Flume*. Such price and payment will be full compensation for all materials, labor, equipment, tools, removing and disposing of the temporary slope drains, and any other incidentals necessary to complete the work satisfactorily.

The concrete curb and ditch outside the pay limits of the apron will be measured and paid in accordance with Section 846 and 850 of the *Standard Specifications*.

Payment will be made under:

**Pay Item**

Modified Concrete Flume

**Pay Unit**

Each

**REMOVE AND REPLACE CONCRETE ISLAND:****Description**

The Contractor shall remove and replace existing island within the limits shown in the plans or as directed. All work for this item shall be in accordance with Section 852 of the *2024 Standard Specifications*. New island shall be 5" Monolithic Concrete Islands (Keyed In) On Asphalt Concrete Pavement as shown on drawing 852.01 in the *2018 Roadway Standard Drawings* regardless of island width.

Disposal of existing island shall be incidental to the item *Remove and Replace Island*.

**Measurement and Payment**

*Remove and Replace Island* will be measured and paid for in units of square yards. Such price and payment will be full compensation for removal and disposal of existing island, excavating, backfilling, forming, placing all concrete, finishing, constructing and sealing joints, and all incidentals necessary to complete the work.

Payment will be made under:

**Pay Item**

Remove and Replace Island

**Pay Unit**

Square Yard

**REMOVE AND REPLACE DRIVEWAY APRON:****Description**

The Contractor shall remove and replace driveway apron within the limits shown in the plans or as directed. All work for this item shall be in accordance with Section 848 of the *2024 Standard Specifications*.

Disposal of existing driveway apron shall be incidental to the item *Remove and Replace Driveway Apron*.

**Measurement and Payment**

*Remove and Replace Driveway Apron* will be measured and paid for in units of square yards. Such price and payment will be full compensation for removal and disposal of existing driveway apron, excavating, backfilling, forming, placing all concrete, finishing, constructing and sealing joints, and all incidentals necessary to complete the work.

Payment will be made under:

**Pay Item**

Remove and Replace Driveway Apron

**Pay Unit**

Square Yard

**REMOVE AND REPLACE SIDEWALK:****Description**

The Contractor shall remove and replace sidewalk within the limits shown in the plans or as directed. All work for this item shall be in accordance with Section 848 of the *2024 Standard Specifications*.

Disposal of existing sidewalk shall be incidental to the item *Remove and Replace Sidewalk*.

**Measurement and Payment**

*Remove and Replace Sidewalk* will be measured and paid for in units of square yards. Such price and payment will be full compensation for removal and disposal of existing sidewalk, excavating, backfilling, forming, placing all concrete, finishing, constructing and sealing joints, and all incidentals necessary to complete the work.

Payment will be made under:

**Pay Item**

Remove and Replace Sidewalk

**Pay Unit**

Square Yard

**REMOVE CONCRETE ISLAND:****Description**

Sawcut, break up, remove, and satisfactorily dispose of the existing island within the limits shown in the plans or as directed. Backfill with suitable soil and seed and mulch the disturbed area per Section 1600 in the *2024 Standard Specifications*.

In locations where partial island removal is to address ADA curb ramp compliance, sidewalks, curb ramps, and other flatwork will be paid for under separate line items. Such locations will be indicated on the plans or directed by the Engineer.

Disposal of existing island shall be incidental to the item *Remove Concrete Island*.

**Measurement and Payment**

*Remove Concrete Island* will be measured and paid in units of Square Yard. Such price and payment will be full compensation for removal and disposal of the existing island, backfilling, seeding, mulching the disturbed area, and all other incidentals necessary to complete the work. Required sidewalks, curb ramps, and other flatwork installed in lieu of backfilling with soil will be paid for under a separate pay item on the itemized bid form.

Payment will be made under:

**Pay Item**

Remove Concrete Island

**Pay Unit**

Square Yard

**REMOVE DRIVEWAY APRON:****Description**

Sawcut, break up, remove, and satisfactorily dispose of the existing driveway apron including the curb cut transitions to the nearest concrete joint within the limits shown in the plans or as directed. Backfill with suitable soil and seed and mulch the disturbed area per Section 1600 in the *2024 Standard Specifications*. The existing curb cut and curb cut transitions will be replaced with curb and gutter to match the existing conditions and will be paid for under a separate pay item on the itemized bid form.

In locations where driveway apron removal is to address ADA curb ramp compliance, sidewalks, curb ramps, and other flatwork will be paid for under separate line items. Such locations will be indicated on the plans or directed by the Engineer.

Disposal of existing driveway apron shall be incidental to the item *Remove Driveway Apron*.

**Measurement and Payment**

*Remove Driveway Apron* will be measured and paid in units of square yards. Such price and payment will be full compensation for removal and disposal of the existing driveway apron, curb

cut, curb cut transitions, backfilling, seeding, mulching the disturbed area, and all other incidentals necessary to complete the work. Required sidewalks, curb ramps, and other flatwork installed in lieu of backfilling with soil will be paid for under a separate pay item on the itemized bid form.

Payment will be made under:

<b>Pay Item</b>	<b>Pay Unit</b>
Remove Driveway Apron	Square Yard

### **REMOVE SIDEWALK:**

#### **Description**

Sawcut, break up, remove, and satisfactorily dispose of the existing sidewalk to the nearest concrete joint within the limits shown in the plans or as directed. Backfill with suitable soil and seed and mulch the disturbed area per Section 1600 in the *2024 Standard Specifications*.

In locations where sidewalk removal is to address ADA curb ramp compliance, sidewalks, curb ramps, and other flatwork will be paid for under separate line items. Such locations will be indicated on the plans or directed by the Engineer.

Disposal of existing sidewalk shall be incidental to the item *Remove Sidewalk*.

#### **Measurement and Payment**

*Remove Sidewalk* will be measured and paid in units of Square Yards. Such price and payment will be full compensation for removal and disposal of the existing sidewalk, backfilling, seeding, mulching the disturbed area, and all other incidentals necessary to complete the work. Required sidewalks, curb ramps, and other flatwork installed in lieu of backfilling with soil will be paid for under a separate pay item on the itemized bid form.

Payment will be made under:

<b>Pay Item</b>	<b>Pay Unit</b>
Remove Sidewalk	Square Yard

### **REMOVE AND REPLACE CURB & GUTTER:**

#### **Description**

The Contractor shall remove and replace existing curb & gutter within the limits shown in the plans or as directed. All work for this item shall be in accordance with Section 846 of the *2024 Standard Specifications*.

Disposal of existing curb & gutter shall be incidental to the item *Remove and Replace Curb & Gutter*.

#### **Measurement and Payment**



*Remove and Replace Curb & Gutter* will be measured and paid for in units of linear feet. Such price and payment will be full compensation for removal and disposal of existing curb & gutter, excavating and backfilling, forming, placing all concrete, finishing, constructing and sealing joints, and all incidentals necessary to complete the work.

Payment will be made under:

**Pay Item**

Remove and Replace Curb & Gutter

**Pay Unit**

Linear Foot

**REMOVE CURB & GUTTER:**

**Description**

Sawcut, break up, remove, and satisfactorily dispose of the existing curb & gutter to the nearest concrete joint within the limits shown in the plans or as directed. Backfill with suitable soil and seed and mulch the disturbed area per Section 1600 in the *2024 Standard Specifications*.

In locations where curb and gutter removal is to address ADA curb ramp compliance, sidewalks, curb ramps, and other flatwork will be paid for under separate line items. Such locations will be indicated on the plans or directed by the Engineer.

Disposal of existing curb & gutter shall be incidental to the item *Remove Curb & Gutter*.

**Measurement and Payment**

*Remove Curb & Gutter* will be measured and paid in units of Linear Feet. Such price and payment will be full compensation for removal and disposal of the curb & gutter, backfilling, seeding, mulching the disturbed area, and all other incidentals necessary to complete the work. Required sidewalks, curb ramps, and other flatwork installed in lieu of backfilling with soil will be paid for under a separate pay item on the itemized bid form.

Payment will be made under:

**Pay Item**

Remove Curb & Gutter

**Pay Unit**

Linear Foot

**REMOVE CURB RAMP:**

**Description**

Sawcut, break up, remove, and satisfactorily dispose of the existing curb ramp and curb cut, including the curb cut transitions, to the nearest concrete joint within the limits shown in the plans or as directed. Backfill with suitable soil and seed and mulch the disturbed area per Section 1600 in the *2024 Standard Specifications*. The existing curb cut and curb cut transitions will be replaced with curb and gutter to match the existing conditions and will be paid for under a separate pay item on the itemized bid form.

In locations where curb ramp removal is to address ADA curb ramp compliance, sidewalks, curb ramps, and other flatwork will be paid for under separate line items. Such locations will be indicated on the plans or directed by the Engineer.

Disposal of existing curb ramp shall be incidental to the item *Remove Curb Ramp*.

### Measurement and Payment

*Remove Curb Ramp* will be measured and paid in units of Each. Such price and payment will be full compensation for removal and disposal of the existing curb ramp, curb cut, curb cut transitions, backfilling, seeding, mulching the disturbed area, and all other incidentals necessary to complete the work. Required sidewalks, curb ramps, and other flatwork installed in lieu of backfilling with soil will be paid for under a separate pay item on the itemized bid form.

Payment will be made under:

<b>Pay Item</b>	<b>Pay Unit</b>
Remove Curb Ramp	Each

### **CONVERT EXISTING CATCH BASIN TO JUNCTION BOX:**

(1-1-02)(Rev. 1-16-23)

840, 859

SP8 R50

At the proper phase of construction, convert the existing catch basin at locations indicated in the plans or where directed, to junction box in accordance with the details in the plans and the applicable requirements of Sections 840 and 859 of the *Standard Specifications*.

*Convert Existing Catch Basin to Junction Box* will be measured and paid as each, completed, and accepted. Such price and payment are considered full compensation for all equipment, materials, labor, tools, and incidentals necessary to complete each conversion satisfactorily.

Payment will be made under:

<b>Pay Item</b>	<b>Pay Unit</b>
Convert Existing Catch Basin to Junction Box	Each

### **CONVERT EXISTING CATCH BASIN TO DROP INLET:**

(1-1-02)(Rev. 1-16-23)

840, 859

SP8 R50

At the proper phase of construction, convert the existing catch basin at locations indicated in the plans or where directed, to drop inlet in accordance with the details in the plans and the applicable requirements of Sections 840 and 859 of the *Standard Specifications*.

*Convert Existing Catch Basin to Drop Inlet* will be measured and paid as each, completed, and accepted. Such price and payment are considered full compensation for all equipment, materials, labor, tools, and incidentals necessary to complete each conversion satisfactorily.

Payment will be made under:

**Pay Item**

Convert Existing Catch Basin to Drop Inlet

**Pay Unit**

Each

**CONVERT EXISTING DROP INLET TO JUNCTION BOX:**

(1-1-02)(Rev. 1-16-23)

840, 859

SP8 R50

At the proper phase of construction, convert the existing drop inlet at locations indicated in the plans or where directed, to junction box in accordance with the details in the plans and the applicable requirements of Sections 840 and 859 of the *Standard Specifications*.

*Convert Existing Drop Inlet to Junction Box* will be measured and paid as each, completed, and accepted. Such price and payment are considered full compensation for all equipment, materials, labor, tools, and incidentals necessary to complete each conversion satisfactorily.

Payment will be made under:

**Pay Item**

Convert Existing Drop Inlet to Junction Box

**Pay Unit**

Each

**CONVERT EXISTING DROP INLET TO CATCH BASIN:**

(1-1-02)(Rev. 1-16-23)

840, 859

SP8 R50

At the proper phase of construction, convert the existing drop inlet at locations indicated in the plans or where directed, to catch basin in accordance with the details in the plans and the applicable requirements of Sections 840 and 859 of the *Standard Specifications*.

*Convert Existing Drop Inlet to Catch Basin* will be measured and paid as each, completed, and accepted. Such price and payment are considered full compensation for all equipment, materials, labor, tools, and incidentals necessary to complete each conversion satisfactorily.

Payment will be made under:

**Pay Item**

Convert Existing Drop Inlet to Catch Basin

**Pay Unit**

Each

**CONVERT EXISTING JUNCTION BOX TO DROP INLET:**

(1-1-02)(Rev. 1-16-23)

840, 859

SP8 R50

At the proper phase of construction, convert the existing junction box at locations indicated in the plans or where directed, to drop inlet in accordance with the details in the plans and the applicable requirements of Sections 840 and 859 of the *Standard Specifications*.

*Convert Existing Junction Box to Drop Inlet* will be measured and paid as each, completed, and accepted. Such price and payment are considered full compensation for all equipment, materials, labor, tools, and incidentals necessary to complete each conversion satisfactorily.

Payment will be made under:

**Pay Item**

Convert Existing Junction Box to Drop Inlet

**Pay Unit**

Each

**CONVERT EXISTING JUNCTION BOX TO CATCH BASIN:**

(1-1-02)(Rev. 1-16-23)

840, 859

SP8 R50

At the proper phase of construction, convert the existing junction box at locations indicated in the plans or where directed, to catch basin in accordance with the details in the plans and the applicable requirements of Sections 840 and 859 of the *Standard Specifications*.

*Convert Existing Junction Box to Catch Basin* will be measured and paid as each, completed, and accepted. Such price and payment are considered full compensation for all equipment, materials, labor, tools, and incidentals necessary to complete each conversion satisfactorily.

Payment will be made under:

**Pay Item**

Convert Existing Junction Box to Catch Basin

**Pay Unit**

Each

**ADJUSTMENT OF MANHOLES:**

(7-1-95)(Rev. 1-16-24)

858

SP8 R95R

The Contractor's attention is directed to Section 858-3 of the *Standard Specifications*.

The use of cast iron or steel fittings in the adjustment of manholes will not be permitted on this project except where it is considered by the Engineer to be in the best interest of the Department to allow rings to be used. When rings are permitted for the adjustment of manholes, the rings shall have satisfactory bearing on the existing manhole frames and 50 percent of the circumference shall be tack welded at four equally spaced locations as directed by the Engineer. If the existing covers do not fit the rings, furnish and install new covers at no additional expense to the Department.

**TRAFFIC CONTROL:**

The Contractor shall maintain traffic, provide traffic control and conduct all phases of his work in accordance with Section 1101 of the *Standard Specifications*, the *Manual on Uniform Traffic Control Devices for Streets and Highways* (MUTCD), the North Carolina Supplement to the MUTCD and per direction of the Engineer.

All personnel when working in traffic areas or areas in close proximity to traffic shall wear an approved safety vest, or shirt or jacket which meets the color requirements of the MUTCD.

The Contractor shall comply with all applicable Federal, State, and local laws, ordinances, and regulations governing safety, health, and sanitation, and shall provide all safeguards, safety devices, and protective equipment, and shall take any other needed actions, on his own responsibility that are reasonably necessary to protect the life and health of employees on the job and the safety of the public, and to protect property in connection with the performance of the work covered by the contract.

Failure to comply with any of the requirements for safety and traffic control of this contract shall result in suspension of work as provided in Sub article 108-7(B) of the *Standard Specifications*.

The Contractor's vehicles and equipment shall not be parked within the State Highway System right of way overnight or at other times when work has been suspended unless approved by the Engineer, and in no case within 30 feet of the edge of pavement. The Engineer may designate specific locations for parking equipment.

The Contractor shall begin removal of the traffic control items upon notification of the Engineer.

Work zone traffic control may be provided by NCDOT, as directed by the Engineer.

Payment for traffic control items shall include all cones, drums, signing, changeable message signs, flashing arrow boards, truck mounted impact attenuators, flaggers, lighting, and incidentals included to install, shift, and remove the lane closure as shown in *Roadway Standard Drawing 1101.02* Sheets 1 thru 19 and shoulder closure as shown in *Roadway Standard Drawing 1101.04* Sheet 1 of 2.

Traffic control pay items will be measured and paid for in units of each per site where the Contractor has installed traffic control.

Payment will be made under:

<b>Pay Item</b>	<b>Pay Unit</b>
Lane Closure, Two-Lane, Two-Way Facility	Each
Lane Closure, Undivided Multi-Lane Facility	Each
Lane Closure, Divided Multi-Lane Facility	Each
Shoulder Closure with Crash Truck	Each
Shoulder Closure without Crash Truck	Each

**STANDARD SPECIAL PROVISION**  
**AVAILABILITY OF FUNDS – TERMINATION OF CONTRACTS**

(5-20-08)(Rev. 1-16-24)

Z-2

*General Statute 143C-6-11. (h) Highway Appropriation* is hereby incorporated verbatim in this contract as follows:

(h) Amounts Encumbered. – Transportation project appropriations may be encumbered in the amount of allotments made to the Department of Transportation by the Director for the estimated payments for transportation project contract work to be performed in the appropriation fiscal year. The allotments shall be multiyear allotments and shall be based on estimated revenues and shall be subject to the maximum contract authority contained in *General Statute 143C-6-11(c)*. Payment for transportation project work performed pursuant to contract in any fiscal year other than the current fiscal year is subject to appropriations by the General Assembly. Transportation project contracts shall contain a schedule of estimated completion progress, and any acceleration of this progress shall be subject to the approval of the Department of Transportation provided funds are available. The State reserves the right to terminate or suspend any transportation project contract, and any transportation project contract shall be so terminated or suspended if funds will not be available for payment of the work to be performed during that fiscal year pursuant to the contract. In the event of termination of any contract, the contractor shall be given a written notice of termination at least 60 days before completion of scheduled work for which funds are available. In the event of termination, the contractor shall be paid for the work already performed in accordance with the contract specifications.

Payment will be made on any contract terminated pursuant to the special provision in accordance with Subarticle 108-13(D) of the *Standard Specifications*.

**STANDARD SPECIAL PROVISION**  
**NCDOT GENERAL SEED SPECIFICATION FOR SEED QUALITY**

(5-17-11)

Z-3

Seed shall be sampled and tested by the North Carolina Department of Agriculture and Consumer Services, Seed Testing Laboratory. When said samples are collected, the vendor shall supply an independent laboratory report for each lot to be tested. Results from seed so sampled shall be final. Seed not meeting the specifications shall be rejected by the Department of Transportation and shall not be delivered to North Carolina Department of Transportation warehouses. If seed has been delivered it shall be available for pickup and replacement at the supplier's expense.

Any re-labeling required by the North Carolina Department of Agriculture and Consumer Services, Seed Testing Laboratory, that would cause the label to reflect as otherwise specified herein shall be rejected by the North Carolina Department of Transportation.

Seed shall be free from seeds of the noxious weeds Johnsongrass, Balloonvine, Jimsonweed, Witchweed, Itchgrass, Serrated Tussock, Showy Crotalaria, Smooth Crotalaria, Sicklepod, Sandbur, Wild Onion, and Wild Garlic. Seed shall not be labeled with the above weed species on the seed analysis label. Tolerances as applied by the Association of Official Seed Analysts will NOT be allowed for the above noxious weeds except for Wild Onion and Wild Garlic.

Tolerances established by the Association of Official Seed Analysts will generally be recognized. However, for the purpose of figuring pure live seed, the found pure seed and found germination percentages as reported by the North Carolina Department of Agriculture and Consumer Services, Seed Testing Laboratory will be used. Allowances, as established by the NCDOT, will be recognized for minimum pure live seed as listed on the following pages.

The specifications for restricted noxious weed seed refers to the number per pound as follows:

<u>Restricted Noxious Weed</u>	<u>Limitations per Lb. Of Seed</u>	<u>Restricted Noxious Weed</u>	<u>Limitations per Lb. of Seed</u>
Blessed Thistle	4 seeds	Cornflower (Ragged Robin)	27 seeds
Cocklebur	4 seeds	Texas Panicum	27 seeds
Spurred Anoda	4 seeds	Bracted Plantain	54 seeds
Velvetleaf	4 seeds	Buckhorn Plantain	54 seeds
Morning-glory	8 seeds	Broadleaf Dock	54 seeds
Corn Cockle	10 seeds	Curly Dock	54 seeds
Wild Radish	12 seeds	Dodder	54 seeds
Purple Nutsedge	27 seeds	Giant Foxtail	54 seeds
Yellow Nutsedge	27 seeds	Horsenettle	54 seeds
Canada Thistle	27 seeds	Quackgrass	54 seeds
Field Bindweed	27 seeds	Wild Mustard	54 seeds
Hedge Bindweed	27 seeds		

Seed of Pensacola Bahiagrass shall not contain more than 7% inert matter, Kentucky Bluegrass, Centipede and Fine or Hard Fescue shall not contain more than 5% inert matter whereas a maximum of 2% inert matter will be allowed on all other kinds of seed. In addition, all seed shall

not contain more than 2% other crop seed nor more than 1% total weed seed. The germination rate as tested by the North Carolina Department of Agriculture shall not fall below 70%, which includes both dormant and hard seed. Seed shall be labeled with not more than 7%, 5% or 2% inert matter (according to above specifications), 2% other crop seed and 1% total weed seed.

Exceptions may be made for minimum pure live seed allowances when cases of seed variety shortages are verified. Pure live seed percentages will be applied in a verified shortage situation. Those purchase orders of deficient seed lots will be credited with the percentage that the seed is deficient.

FURTHER SPECIFICATIONS FOR EACH SEED GROUP ARE GIVEN BELOW:

Minimum 85% pure live seed; maximum 1% total weed seed; maximum 2% total other crop seed; maximum 144 restricted noxious weed seed per pound. Seed less than 83% pure live seed will not be approved.

Sericea Lespedeza  
Oats (seeds)

Minimum 80% pure live seed; maximum 1% total weed seed; maximum 2% total other crop; maximum 144 restricted noxious weed seed per pound. Seed less than 78% pure live seed will not be approved.

Tall Fescue (all approved varieties)	Bermudagrass
Kobe Lespedeza	Browntop Millet
Korean Lespedeza	German Millet – Strain R
Weeping Lovegrass	Clover – Red/White/Crimson
Carpetgrass	

Minimum 78% pure live seed; maximum 1% total weed seed; maximum 2% total other crop seed; maximum 144 restricted noxious weed seed per pound. Seed less than 76% pure live seed will not be approved.

Common or Sweet Sundangrass

Minimum 76% pure live seed; maximum 1% total weed seed; maximum 2% total other crop seed; maximum 144 restricted noxious weed seed per pound. Seed less than 74% pure live seed will not be approved.

Rye (grain; all varieties)  
Kentucky Bluegrass (all approved varieties)  
Hard Fescue (all approved varieties)  
Shrub (bicolor) Lespedeza

Minimum 70% pure live seed; maximum 1% total weed seed; maximum 2% total other crop seed; maximum 144 noxious weed seed per pound. Seed less than 70% pure live seed will not be approved.

Centipede grass	Japanese Millet
Crownvetch	Reed Canary Grass
Pensacola Bahiagrass	Zoysia
Creeping Red Fescue	



Minimum 70% pure live seed; maximum 1% total weed seed; maximum 2% total other crop seed; maximum 5% inert matter; maximum 144 restricted noxious weed seed per pound.

Barnyard Grass  
Big Bluestem  
Little Bluestem  
Bristly Locust  
Birdsfoot Trefoil  
Indiangrass  
Orchardgrass  
Switchgrass  
Yellow Blossom Sweet Clover

**STANDARD SPECIAL PROVISION**  
**ERRATA**

(1-16-24)

Z-4

Revise the *2024 Standard Specifications* as follows:

**Division 3**

**Page 3-5, Article 305-2 MATERIALS, after line 16,** replace " 1032-3(A)(7)" with "1032-3" and add the item "Galvanized Corrugated Steel Pipe" with Section "1032-3".

**Page 3-6, Article 310-2 MATERIALS, after line 9,** add the item "Galvanized Corrugated Steel Pipe" with Section "1032-3".

**Division 9**

**Page 9-17, Article 904-4 MEASUREMENT AND PAYMENT, prior to line 1,** replace " Sign Erection, Relocate Type (Ground Mounted)" with "Sign Erection, Relocate Type \_\_\_ (Ground Mounted)".

**Division 10**

**Page 10-51, Article 1024-4 WATER, prior to line 1,** delete the "unpopulated blank row" in Table 1024-2 between "Time of set, deviation from control" and "Chloride Ion Content, Max.".

**Page 10-170, Subarticle 1081-1(C) Requirements, line 4,** replace "maximum" with "minimum".

**Division 11**

**Page 11-15, Article 1160-4 MEASUREMENT AND PAYMENT, line 24,** replace "Where barrier units are moved more than one" with "Where barrier units are moved more than once".

**Division 15**

**Page 15-10, Article 1515-4 MEASUREMENT AND PAYMENT, lines 11,** replace " All piping" with "All labor, the manhole, other materials, excavation, backfilling, piping".

**Division 16**

**Page 16-14, Article 1633-5 MEASUREMENT AND PAYMENT, line 20-24 and prior to line 25,** delete and replace with the following " *Flocculant* will be measured and paid in accordance with Article 1642-5 applied to the temporary rock silt checks."

**Page 16-3, Article 1609-2 MATERIALS, after line 26,** replace "Type 4" with "Type 4a".

**Page 16-25, Article 1644-2 MATERIALS, after line 22,** replace "Type 4" with "Type 4a".

**STANDARD SPECIAL PROVISION****PLANT AND PEST QUARANTINES****(Imported Fire Ant, Gypsy Moth, Witchweed, Emerald Ash Borer, Guava Root Knot Nematode, And Other Noxious Weeds)**

(3-18-03) (Rev. 5-21-19)

Z-04a

**Within Quarantined Area**

This project may be within a county regulated for plant and/or pests. If the project or any part of the Contractor's operations is located within a quarantined area, thoroughly clean all equipment prior to moving out of the quarantined area. Comply with federal/state regulations by obtaining a certificate or limited permit for any regulated article moving from the quarantined area.

**Originating in a Quarantined County**

Obtain a certificate or limited permit issued by the N.C. Department of Agriculture/United States Department of Agriculture. Have the certificate or limited permit accompany the article when it arrives at the project site.

**Contact**

Contact the N.C. Department of Agriculture/United States Department of Agriculture at 1-800-206-9333, 919-707-3730, or <https://www.ncagr.gov/plantindustry/Plant/quaran/table2.htm> to determine those specific project sites located in the quarantined area or for any regulated article used on this project originating in a quarantined county.

**Regulated Articles Include**

1. Soil, sand, gravel, compost, peat, humus, muck, and decomposed manure, separately or with other articles. This includes movement of articles listed above that may be associated with cut/waste, ditch pulling, and shoulder cutting.
2. Plants with roots including grass sod.
3. Plant crowns and roots.
4. Bulbs, corms, rhizomes, and tubers of ornamental plants.
5. Hay, straw, fodder, and plant litter of any kind.
6. Clearing and grubbing debris.
7. Used agricultural cultivating and harvesting equipment.
8. Used earth-moving equipment.
9. Any other products, articles, or means of conveyance, of any character, if determined by an inspector to present a hazard of spreading imported fire ant, gypsy moth, witchweed, emerald ash borer, guava root knot nematode, or other noxious weeds.

**STANDARD SPECIAL PROVISION****MINIMUM WAGES**

(7-21-09)

Z-5

**FEDERAL:** The Fair Labor Standards Act provides that with certain exceptions every employer shall pay wages at the rate of not less than SEVEN DOLLARS AND TWENTY FIVE CENTS (\$7.25) per hour.

**STATE:** The North Carolina Minimum Wage Act provides that every employer shall pay to each of his employees, wages at a rate of not less than SEVEN DOLLARS AND TWENTY FIVE CENTS (\$7.25) per hour.

The minimum wage paid to all skilled labor employed on this contract shall be SEVEN DOLLARS AND TWENTY FIVE CENTS (\$7.25) per hour.

The minimum wage paid to all intermediate labor employed on this contract shall be SEVEN DOLLARS AND TWENTY FIVE CENTS (\$7.25) per hour.

The minimum wage paid to all unskilled labor on this contract shall be SEVEN DOLLARS AND TWENTY FIVE CENTS (\$7.25) per hour.

This determination of the intent of the application of this act to the contract on this project is the responsibility of the Contractor.

The Contractor shall have no claim against the Department of Transportation for any changes in the minimum wage laws, Federal or State. It is the responsibility of the Contractor to keep fully informed of all Federal and State Laws affecting his contract.

**STANDARD SPECIAL PROVISION****TITLE VI AND NONDISCRIMINATION:**

(6-28-77)(Rev 1/16/2024)

Z-6

The North Carolina Department of Transportation is committed to carrying out the U.S. Department of Transportation's policy of ensuring nondiscrimination in the award and administration of contracts.

The provisions of this section related to United States Department of Transportation (US DOT) Order 1050.2A, Title 49 Code of Federal Regulations (CFR) part 21, 23 United States Code (U.S.C.) 140 and 23 CFR part 200 (or 49 CFR 303, 49 U.S.C. 5332 or 49 U.S.C. 47123) are applicable to all North Carolina Department of Transportation (NCDOT) contracts and to all related subcontracts, material supply, engineering, architectural and other service contracts, regardless of dollar amount. Any Federal provision that is specifically required not specifically set forth is hereby incorporated by reference.

**(1) Title VI Assurances (USDOT Order 1050.2A, Appendix A)**

During the performance of this contract, the contractor, for itself, its assignees, and successors in interest (hereinafter referred to as the "contractor") agrees as follows:

**(a) Compliance with Regulations**

The contractor (hereinafter includes consultants) shall comply with the Acts and the Regulations relative to Nondiscrimination in Federally-assisted programs of the U.S. Department of Transportation, Federal Highway Administration (FHWA), as they may be amended from time to time, which are herein incorporated by reference and made a part of this contract.

**(b) Nondiscrimination**

The contractor, with regard to the work performed by it during the contract, shall not discriminate on the grounds of race, color, or national origin in the selection and retention of subcontractors, including procurements of materials and leases of equipment. The contractor shall not participate directly or indirectly in the discrimination prohibited by the Acts and the Regulations, including employment practices when the contract covers any activity, project, or program set forth in Appendix B of 49 CFR Part 21.

**(c) Solicitations for Subcontractors, Including Procurements of Materials and Equipment**

In all solicitations, either by competitive bidding, or negotiation made by the contractor for work to be performed under a subcontract, including procurements of materials, or leases of equipment, each potential subcontractor or supplier shall be notified by the contractor of the contractor's obligations under this contract and the Acts and the Regulations relative to Nondiscrimination on the grounds of race, color, or national origin.

**(d) Information and Reports**

The contractor shall provide all information and reports required by the Acts, the Regulations, and directives issued pursuant thereto and shall permit access to its books,

records, accounts, other sources of information, and its facilities as may be determined by the Recipient or the FHWA to be pertinent to ascertain compliance with such Acts, Regulations, and instructions. Where any information required of a contractor is in the exclusive possession of another who fails or refuses to furnish the information, the contractor shall so certify to the Recipient or the FHWA, as appropriate, and shall set forth what efforts it has made to obtain the information.

(e) Sanctions for Noncompliance:

In the event of a contractor's noncompliance with the Non-discrimination provisions of this contract, the Recipient will impose such contract sanctions as it and/or the FHWA may determine to be appropriate, including, but not limited to:

- (i) Withholding payments to the contractor under the contract until the contractor complies; and/or
- (ii) Cancelling, terminating, or suspending a contract, in whole or in part.

(f) Incorporation of Provisions

The contractor shall include the provisions of paragraphs (a) through (f) in every subcontract, including procurements of materials and leases of equipment, unless exempt by the Acts, the Regulations and directives issued pursuant thereto. The contractor shall take action with respect to any subcontract or procurement as the Recipient or the FHWA may direct as a means of enforcing such provisions including sanctions for noncompliance. Provided, that if the contractor becomes involved in, or is threatened with litigation by a subcontractor, or supplier because of such direction, the contractor may request the Recipient to enter into any litigation to protect the interests of the Recipient. In addition, the contractor may request the United States to enter into the litigation to protect the interests of the United States.

**(2) Title VI Nondiscrimination Program (23 CFR 200.5(p))**

The North Carolina Department of Transportation (NCDOT) has assured the USDOT that, as a condition to receiving federal financial assistance, NCDOT will comply with Title VI of the Civil Rights Act of 1964 and all requirements imposed by Title 49 CFR part 21 and related nondiscrimination authorities to ensure that no person shall, on the ground of race, color, national origin, limited English proficiency, sex, age, or disability (including religion/creed or income-level, where applicable), be excluded from participation in, be denied the benefits of, or be subjected to discrimination under any programs, activities, or services conducted or funded by NCDOT. Contractors and other organizations under contract or agreement with NCDOT must also comply with Title VI and related authorities, therefore:

- (a) During the performance of this contract or agreement, contractors (e.g., subcontractors, consultants, vendors, prime contractors) are responsible for complying with NCDOT's Title VI Program. Contractors are not required to prepare or submit Title VI Programs. To comply with this section, the prime contractor shall:
  1. Post NCDOT's Notice of Nondiscrimination and the Contractor's own Equal Employment Opportunity (EEO) Policy in conspicuous locations accessible to all employees, applicants and subcontractors on the jobsite.

2. Physically incorporate the required Title VI clauses into all subcontracts on federally-assisted and state-funded NCDOT projects, and ensure inclusion by subcontractors into all lower-tier subcontracts.
  3. Required Solicitation Language. The Contractor shall include the following notification in all solicitations for bids and requests for work or material, regardless of funding source:

“The North Carolina Department of Transportation, in accordance with the provisions of Title VI of the Civil Rights Act of 1964 (78 Stat. 252, 42 U.S.C. §§ 2000d to 2000d-4) and the Regulations, hereby notifies all bidders that it will affirmatively ensure that any contract entered into pursuant to this advertisement, disadvantaged business enterprises will be afforded full and fair opportunity to submit bids in response to this invitation and will not be discriminated against on the grounds of race, color, or national origin in consideration for an award. In accordance with other related nondiscrimination authorities, bidders and contractors will also not be discriminated against on the grounds of sex, age, disability, low-income level, creed/religion, or limited English proficiency in consideration for an award.”
  4. Physically incorporate the FHWA-1273, in its entirety, into all subcontracts and subsequent lower tier subcontracts on Federal-aid highway construction contracts only.
  5. Provide language assistance services (i.e., written translation and oral interpretation), free of charge, to LEP employees and applicants. Contact NCDOT OCR for further assistance, if needed.
  6. For assistance with these Title VI requirements, contact the NCDOT Title VI Nondiscrimination Program at 1-800-522-0453.
- (b) Subrecipients (e.g. cities, counties, LGAs, planning organizations) may be required to prepare and submit a Title VI Plan to NCDOT, including Title VI Assurances and/or agreements. Subrecipients must also ensure compliance by their contractors and subrecipients with Title VI. (23 CFR 200.9(b)(7))
- (c) If reviewed or investigated by NCDOT, the contractor or subrecipient agrees to take affirmative action to correct any deficiencies found within a reasonable time period, not to exceed 90 calendar days, unless additional time is granted by NCDOT. (23 CFR 200.9(b)(15))
- (d) The Contractor is responsible for notifying subcontractors of NCDOT’s External Discrimination Complaints Process.
1. Applicability

Title VI and related laws protect participants and beneficiaries (e.g., members of the public and contractors) from discrimination by NCDOT employees, subrecipients and contractors, regardless of funding source.

## 2. Eligibility

Any person—or class of persons—who believes he/she has been subjected to discrimination based on race, color, national origin, Limited English Proficiency (LEP), sex, age, or disability (and religion in the context of employment, aviation, or transit) may file a written complaint. The law also prohibits intimidation or retaliation of any sort.

## 3. Time Limits and Filing Options

Complaints may be filed by the affected individual(s) or a representative and must be filed no later than 180 calendar days after the following:

- (i) The date of the alleged act of discrimination; or
- (ii) The date when the person(s) became aware of the alleged discrimination; or
- (iii) Where there has been a continuing course of conduct, the date on which that conduct was discontinued or the latest instance of the conduct.

Title VI and related discrimination complaints may be submitted to the following entities:

- North Carolina Department of Transportation, Office of Civil Rights, Title VI Program, 1511 Mail Service Center, Raleigh, NC 27699-1511; toll free 1-800-522-0453
- Federal Highway Administration, North Carolina Division Office, 310 New Bern Avenue, Suite 410, Raleigh, NC 27601, 919-747-7010
- US Department of Transportation, Departmental Office of Civil Rights, External Civil Rights Programs Division, 1200 New Jersey Avenue, SE, Washington, DC 20590; 202-366-4070

## 4. Format for Complaints

Complaints must be in writing and signed by the complainant(s) or a representative, and include the complainant's name, address, and telephone number. Complaints received by fax or e-mail will be acknowledged and processed. Allegations received by telephone will be reduced to writing and provided to the complainant for confirmation or revision before processing. Complaints will be accepted in other languages, including Braille.

## 5. Discrimination Complaint Form

Contact NCDOT Civil Rights to receive a full copy of the Discrimination Complaint Form and procedures.

## 6. Complaint Basis

Allegations must be based on issues involving race, color, national origin (LEP), sex, age, disability, or religion (in the context of employment, aviation or transit). "Basis" refers to the complainant's membership in a protected group category.



**TABLE 103-1  
COMPLAINT BASIS**

Protected Categories	Definition	Examples	Applicable Nondiscrimination Authorities
Race and Ethnicity	An individual belonging to one of the accepted racial groups; or the perception, based usually on physical characteristics that a person is a member of a racial group	Black/African American, Hispanic/Latino, Asian, American Indian/Alaska Native, Native Hawaiian/Pacific Islander, White	Title VI of the Civil Rights Act of 1964; 49 CFR Part 21; 23 CFR 200; 49 U.S.C. 5332(b); 49 U.S.C. 47123. <i>(Executive Order 13166)</i>
Color	Color of skin, including shade of skin within a racial group	Black, White, brown, yellow, etc.	
National Origin <i>(Limited English Proficiency)</i>	Place of birth. Citizenship is not a factor. <i>(Discrimination based on language or a person's accent is also covered)</i>	Mexican, Cuban, Japanese, Vietnamese, Chinese	
Sex	Gender. The sex of an individual. <i>Note: Sex under this program does not include sexual orientation.</i>	Women and Men	1973 Federal-Aid Highway Act; 49 U.S.C. 5332(b); 49 U.S.C. 47123.
Age	Persons of any age	21-year-old person	Age Discrimination Act of 1975 49 U.S.C. 5332(b); 49 U.S.C. 47123.
Disability	Physical or mental impairment, permanent or temporary, or perceived.	Blind, alcoholic, para-amputee, epileptic, diabetic, arthritic	Section 504 of the Rehabilitation Act of 1973; Americans with Disabilities Act of 1990
Religion (in the context of employment) <i>(Religion/ Creed in all aspects of any aviation or transit-related construction)</i>	An individual belonging to a religious group; or the perception, based on distinguishable characteristics that a person is a member of a religious group. In practice, actions taken as a result of the moral and ethical beliefs as to what is right and wrong, which are sincerely held with the strength of traditional religious views. <i>Note: Does not have to be associated with a recognized religious group or church; if an individual sincerely holds to the belief, it is a protected religious practice.</i>	Muslim, Christian, Sikh, Hindu, etc.	Title VII of the Civil Rights Act of 1964; 23 CFR 230; FHWA-1273 Required Contract Provisions. <i>(49 U.S.C. 5332(b); 49 U.S.C. 47123)</i>

### (3) Pertinent Nondiscrimination Authorities

During the performance of this contract, the contractor, for itself, its assignees, and successors in interest agrees to comply with the following non-discrimination statutes and authorities, including, but not limited to:

- (a) Title VI of the Civil Rights Act of 1964 (42 U.S.C. § 2000d et seq., 78 stat. 252), (prohibits discrimination on the basis of race, color, national origin); and 49 CFR Part 21.

- (b) The Uniform Relocation Assistance and Real Property Acquisition Policies Act of 1970, (42 U.S.C. § 4601), (prohibits unfair treatment of persons displaced or whose property has been acquired because of Federal or Federal-aid programs and projects);
- (c) Federal-Aid Highway Act of 1973, (23 U.S.C. § 324 et seq.), (prohibits discrimination on the basis of sex);
- (d) Section 504 of the Rehabilitation Act of 1973, (29 U.S.C. § 794 et seq.), as amended, (prohibits discrimination on the basis of disability) and 49 CFR Part 27;
- (e) The Age Discrimination Act of 1975, as amended, (42 U.S.C. § 6101 et seq.), (prohibits discrimination on the basis of age);
- (f) Airport and Airway Improvement Act of 1982, (49 USC § 471, Section 47123), as amended, (prohibits discrimination based on race, creed, color, national origin, or sex);
- (g) The Civil Rights Restoration Act of 1987, (PL 100-209), (Broadened the scope, coverage and applicability of Title VI of the Civil Rights Act of 1964, The Age Discrimination Act of 1975 and Section 504 of the Rehabilitation Act of 1973, by expanding the definition of the terms "programs or activities" to include all of the programs or activities of the Federal-aid recipients, sub-recipients and contractors, whether such programs or activities are Federally funded or not);
- (h) Titles II and III of the Americans with Disabilities Act, which prohibit discrimination on the basis of disability in the operation of public entities, public and private transportation systems, places of public accommodation, and certain testing entities (42 U.S.C. §§ 12131-12189) as implemented by Department of Transportation regulations at 49 C.F.R. parts 37 and 38;
- (i) The Federal Aviation Administration's Nondiscrimination statute (49 U.S.C. § 47123) (prohibits discrimination on the basis of race, color, national origin, and sex);
- (j) Executive Order 12898, Federal Actions to Address Environmental Justice in Minority Populations and Low-Income Populations, which ensures Nondiscrimination against minority populations by discouraging programs, policies, and activities with disproportionately high and adverse human health or environmental effects on minority and low-income populations;
- (k) Executive Order 13166, Improving Access to Services for Persons with Limited English Proficiency, and resulting agency guidance, national origin discrimination includes discrimination because of Limited English proficiency (LEP). To ensure compliance with Title VI, you must take reasonable steps to ensure that LEP persons have meaningful access to your programs (70 Fed. Reg. at 74087 to 74100);
- (l) Title IX of the Education Amendments of 1972, as amended, which prohibits you from discriminating because of sex in education programs or activities (20 U.S.C. 1681 et seq).
- (m) Title VII of the Civil Rights Act of 1964 (42 U.S.C. § 2000e et seq., Pub. L. 88-352), (prohibits employment discrimination on the basis of race, color, religion, sex, or national origin).

**(4) Additional Title VI Assurances**

*\*\*The following Title VI Assurances (Appendices B, C and D) shall apply, as applicable*

- (a) Clauses for Deeds Transferring United States Property (1050.2A, Appendix B)

The following clauses will be included in deeds effecting or recording the transfer of real property, structures, or improvements thereon, or granting interest therein from the United States pursuant to the provisions of Assurance 4.

NOW, THEREFORE, the U.S. Department of Transportation as authorized by law and upon the condition that the North Carolina Department of Transportation (NCDOT) will accept title to the lands and maintain the project constructed thereon in accordance with the North Carolina General Assembly, the Regulations for the Administration of the Federal-Aid Highway Program, and the policies and procedures prescribed by the Federal Highway Administration of the U.S. Department of Transportation in accordance and in compliance with all requirements imposed by Title 49, Code of Federal Regulations, U.S. Department of Transportation, Subtitle A, Office of the Secretary, Part 21, Nondiscrimination in Federally-assisted programs of the U.S. Department of Transportation pertaining to and effectuating the provisions of Title VI of the Civil Rights Act of 1964 (78 Stat. 252; 42 U.S.C. § 2000d to 2000d-4), does hereby remise, release, quitclaim and convey unto the NCDOT all the right, title and interest of the U.S. Department of Transportation in and to said lands described in Exhibit A attached hereto and made a part hereof.

(HABENDUM CLAUSE)

TO HAVE AND TO HOLD said lands and interests therein unto the North Carolina Department of Transportation (NCDOT) and its successors forever, subject, however, to the covenants, conditions, restrictions and reservations herein contained as follows, which will remain in effect for the period during which the real property or structures are used for a purpose for which Federal financial assistance is extended or for another purpose involving the provision of similar services or benefits and will be binding on the NCDOT, its successors and assigns.

The NCDOT, in consideration of the conveyance of said lands and interests in lands, does hereby covenant and agree as a covenant running with the land for itself, its successors and assigns, that (1) no person will on the grounds of race, color, or national origin, be excluded from participation in, be denied the benefits of, or be otherwise subjected to discrimination with regard to any facility located wholly or in part on, over, or under such lands hereby conveyed [,] [and]\* (2) that the NCDOT will use the lands and interests in lands and interests in lands so conveyed, in compliance with all requirements imposed by or pursuant to Title 49, Code of Federal Regulations, U.S. Department of Transportation, Subtitle A, Office of the Secretary, Part 21, Nondiscrimination in Federally-assisted programs of the U.S. Department of Transportation, Effectuation of Title VI of the Civil Rights Act of 1964, and as said Regulations and Acts may be amended [, and (3) that in the event of breach of any of the above-mentioned nondiscrimination conditions, the Department will have a right to enter or re-enter said lands and facilities on said land, and that above described land and facilities will thereon revert to and vest in and become the absolute property of the U.S. Department of Transportation and its assigns as such interest existed prior to this instruction].\*

(\*Reverter clause and related language to be used only when it is determined that such a clause is necessary in order to make clear the purpose of Title VI.)

(b) Clauses for Transfer of Real Property Acquired or Improved Under the Activity, Facility, or Program (1050.2A, Appendix C)

The following clauses will be included in deeds, licenses, leases, permits, or similar instruments entered into by the North Carolina Department of Transportation (NCDOT) pursuant to the provisions of Assurance 7(a):

1. The (grantee, lessee, permittee, etc. as appropriate) for himself/herself, his/her heirs, personal representatives, successors in interest, and assigns, as a part of the consideration hereof, does hereby covenant and agree [in the case of deeds and leases add "as a covenant running with the land"] that:
  - (i.) In the event facilities are constructed, maintained, or otherwise operated on the property described in this (deed, license, lease, permit, etc.) for a purpose for which a U.S. Department of Transportation activity, facility, or program is extended or for another purpose involving the provision of similar services or benefits, the (grantee, licensee, lessee, permittee, etc.) will maintain and operate such facilities and services in compliance with all requirements imposed by the Acts and Regulations (as may be amended) such that no person on the grounds of race, color, or national origin, will be excluded from participation in, denied the benefits of, or be otherwise subjected to discrimination in the use of said facilities.
2. With respect to licenses, leases, permits, etc., in the event of breach of any of the above Nondiscrimination covenants, the NCDOT will have the right to terminate the (lease, license, permit, etc.) and to enter, re-enter, and repossess said lands and facilities thereon, and hold the same as if the (lease, license, permit, etc.) had never been made or issued. \*
3. With respect to a deed, in the event of breach of any of the above Nondiscrimination covenants, the NCDOT will have the right to enter or re-enter the lands and facilities thereon, and the above described lands and facilities will there upon revert to and vest in and become the absolute property of the NCDOT and its assigns. \*

(\*Reverter clause and related language to be used only when it is determined that such a clause is necessary to make clear the purpose of Title VI.)

(c) Clauses for Construction/Use/Access to Real Property Acquired Under the Activity, Facility or Program (1050.2A, Appendix D)

The following clauses will be included in deeds, licenses, permits, or similar instruments/ agreements entered into by the North Carolina Department of Transportation (NCDOT) pursuant to the provisions of Assurance 7(b):

1. The (grantee, licensee, permittee, etc., as appropriate) for himself/herself, his/her heirs, personal representatives, successors in interest, and assigns, as a part of the consideration hereof, does hereby covenant and agree (in the case of deeds and leases add, "as a covenant running with the land") that (1) no person on the ground of race, color, or national origin, will be excluded from participation in, denied the benefits of, or be otherwise subjected to discrimination in the use of said facilities, (2) that in the construction of any improvements on, over, or under such land, and the furnishing of services thereon, no person on the ground of race, color, or national origin, will be excluded from participation in, denied the benefits of, or otherwise be subjected to discrimination, (3) that the (grantee, licensee, lessee, permittee, etc.) will use the premises in compliance with all other requirements imposed by or pursuant to the Acts and Regulations, as amended, set forth in this Assurance.
2. With respect to (licenses, leases, permits, etc.), in the event of breach of any of the above Non-discrimination covenants, the NCDOT will have the right to terminate the (license, permit, etc., as appropriate) and to enter or re-enter and repossess said land and the facilities thereon, and hold the same as if said (license, permit, etc., as appropriate) had never been made or issued. \*
3. With respect to deeds, in the event of breach of any of the above Nondiscrimination covenants, the NCDOT will there upon revert to and vest in and become the absolute property of the NCDOT and its assigns. \*

(\*Reverter clause and related language to be used only when it is determined that such a clause is necessary to make clear the purpose of Title VI.)

**STANDARD SPECIAL PROVISION****ON-THE-JOB TRAINING**

(10-16-07) (Rev. 4-21-15)

Z-10

**Description**

The North Carolina Department of Transportation will administer a custom version of the Federal On-the-Job Training (OJT) Program, commonly referred to as the Alternate OJT Program. All contractors (existing and newcomers) will be automatically placed in the Alternate Program. Standard OJT requirements typically associated with individual projects will no longer be applied at the project level. Instead, these requirements will be applicable on an annual basis for each contractor administered by the OJT Program Manager.

On the Job Training shall meet the requirements of 23 CFR 230.107 (b), 23 USC – Section 140, this provision and the On-the-Job Training Program Manual.

The Alternate OJT Program will allow a contractor to train employees on Federal, State and privately funded projects located in North Carolina. However, priority shall be given to training employees on NCDOT Federal-Aid funded projects.

**Minorities and Women**

Developing, training and upgrading of minorities and women toward journeyman level status is a primary objective of this special training provision. Accordingly, the Contractor shall make every effort to enroll minority and women as trainees to the extent that such persons are available within a reasonable area of recruitment. This training commitment is not intended, and shall not be used, to discriminate against any applicant for training, whether a member of a minority group or not.

**Assigning Training Goals**

The Department, through the OJT Program Manager, will assign training goals for a calendar year based on the contractors' past three years' activity and the contractors' anticipated upcoming year's activity with the Department. At the beginning of each year, all contractors eligible will be contacted by the Department to determine the number of trainees that will be assigned for the upcoming calendar year. At that time the Contractor shall enter into an agreement with the Department to provide a self-imposed on-the-job training program for the calendar year. This agreement will include a specific number of annual training goals agreed to by both parties. The number of training assignments may range from 1 to 15 per contractor per calendar year. The Contractor shall sign an agreement to fulfill their annual goal for the year.\

### **Training Classifications**

The Contractor shall provide on-the-job training aimed at developing full journeyman level workers in the construction craft/operator positions. Preference shall be given to providing training in the following skilled work classifications:

Equipment Operators	Office Engineers
Truck Drivers	Estimators
Carpenters	Iron / Reinforcing Steel Workers
Concrete Finishers	Mechanics
Pipe Layers	Welders

The Department has established common training classifications and their respective training requirements that may be used by the contractors. However, the classifications established are not all-inclusive. Where the training is oriented toward construction applications, training will be allowed in lower-level management positions such as office engineers and estimators. Contractors shall submit new classifications for specific job functions that their employees are performing. The Department will review and recommend for acceptance to FHWA the new classifications proposed by contractors, if applicable. New classifications shall meet the following requirements:

Proposed training classifications are reasonable and realistic based on the job skill classification needs, and

The number of training hours specified in the training classification is consistent with common practices and provides enough time for the trainee to obtain journeyman level status.

The Contractor may allow trainees to be trained by a subcontractor provided that the Contractor retains primary responsibility for meeting the training and this provision is made applicable to the subcontract. However, only the Contractor will receive credit towards the annual goal for the trainee.

Where feasible, 25 percent of apprentices or trainees in each occupation shall be in their first year of apprenticeship or training. The number of trainees shall be distributed among the work classifications on the basis of the contractor's needs and the availability of journeymen in the various classifications within a reasonable area of recruitment.

No employee shall be employed as a trainee in any classification in which they have successfully completed a training course leading to journeyman level status or in which they have been employed as a journeyman.

### **Records and Reports**

The Contractor shall maintain enrollment, monthly and completion reports documenting company compliance under these contract documents. These documents and any other information as requested shall be submitted to the OJT Program Manager.

Upon completion and graduation of the program, the Contractor shall provide each trainee with a certification Certificate showing the type and length of training satisfactorily completed.

**Trainee Interviews**

All trainees enrolled in the program will receive an initial and Trainee/Post graduate interview conducted by the OJT program staff.

**Trainee Wages**

Contractors shall compensate trainees on a graduating pay scale based upon a percentage of the prevailing minimum journeyman wages (Davis-Bacon Act). Minimum pay shall be as follows:

60 percent	of the journeyman wage for the first half of the training period
75 percent	of the journeyman wage for the third quarter of the training period
90 percent	of the journeyman wage for the last quarter of the training period

In no instance shall a trainee be paid less than the local minimum wage. The Contractor shall adhere to the minimum hourly wage rate that will satisfy both the NC Department of Labor (NCDOL) and the Department.

**Achieving or Failing to Meet Training Goals**

The Contractor will be credited for each trainee employed by him on the contract work who is currently enrolled or becomes enrolled in an approved program and who receives training for at least 50 percent of the specific program requirement. Trainees will be allowed to be transferred between projects if required by the Contractor's scheduled workload to meet training goals.

If a contractor fails to attain their training assignments for the calendar year, they may be taken off the NCDOT's Bidders List.

**Measurement and Payment**

No compensation will be made for providing required training in accordance with these contract documents.



**THIS PAGE INTENTIONALLY LEFT BLANK**

## PROJECT SPECIAL PROVISIONS

### EROSION CONTROL

#### MINIMIZE REMOVAL OF VEGETATION:

The Contractor shall minimize removal of vegetation within project limits to the maximum extent practicable. Vegetation along stream banks and adjacent to other jurisdictional resources outside the construction limits shall only be removed upon approval of Engineer. No additional payment will be made for this minimization work.

#### PERMANENT SOIL REINFORCEMENT MAT:

##### **Description**

This work consists of furnishing and placing *Permanent Soil Reinforcement Mat*, of the type specified, over previously prepared areas as directed.

##### **Materials**

The product shall be a permanent erosion control reinforcement mat and shall be constructed of synthetic or a combination of coconut and synthetic fibers evenly distributed throughout the mat between a bottom UV stabilized netting and a heavy duty UV stabilized top net. The matting shall be stitched together with UV stabilized polypropylene thread to form a permanent three-dimensional structure. The mat shall have the following minimum physical properties:

<b>Property</b>	<b>Test Method</b>	<b>Value</b>	<b>Unit</b>
Light Penetration	ASTM D6567	9	%
Thickness	ASTM D6525	0.40	in
Mass Per Unit Area	ASTM D6566	0.55	lb/sy
Tensile Strength	ASTM D6818	385	lb/ft
Elongation (Maximum)	ASTM D6818	49	%
Resiliency	ASTM D1777	>70	%
UV Stability *	ASTM D4355	≥80	%
Porosity (Permanent Net)	ECTC Guidelines	≥85	%
Maximum Permissible Shear Stress (Vegetated)	Performance Bench Test	≥8.0	lb/ft <sup>2</sup>
Maximum Allowable Velocity (Vegetated)	Performance Bench Test	≥16.0	ft/s

\*ASTM D1682 Tensile Strength and % strength retention of material after 1000 hours of exposure.

Submit a certification (Type 1, 2, or 3) from the manufacturer showing:

- (A) the chemical and physical properties of the mat used, and
- (B) conformance of the mat with this specification.

## Construction Methods

Matting shall be installed in accordance with Subarticle 1631-3(B) of the *Standard Specifications*.

All areas to be protected with the mat shall be brought to final grade and seeded in accordance with Section 1660 of the *Standard Specifications*. The surface of the soil shall be smooth, firm, stable and free of rocks, clods, roots or other obstructions that would prevent the mat from lying in direct contact with the soil surface. Areas where the mat is to be placed will not need to be mulched.

## Measurement and Payment

*Permanent Soil Reinforcement Mat* will be measured and paid for as the actual number of square yards measured along the surface of the ground over which Permanent Soil Reinforcement Mat is installed and accepted. Overlaps will not be included in the measurement, and will be considered as incidental to the work. Such payment shall be full compensation for furnishing and installing the mat, including overlaps, and for all required maintenance.

Payment will be made under:

Pay Item	Pay Unit
Permanent Soil Reinforcement Mat	Square Yard

## **STABILIZATION REQUIREMENTS:**

(4-30-2019)

Stabilization for this project shall comply with the time frame guidelines as specified by the NCG-010000 general construction permit effective April 1, 2019 issued by the North Carolina Department of Environmental Quality Division of Water Resources. Temporary or permanent ground cover stabilization shall occur within 7 calendar days from the last land-disturbing activity, with the following exceptions in which temporary or permanent ground cover shall be provided in 14 calendar days from the last land-disturbing activity:

- Slopes between 2:1 and 3:1, with a slope length of 10 ft. or less
- Slopes 3:1 or flatter, with a slope of length of 50 ft. or less
- Slopes 4:1 or flatter

The stabilization timeframe for High Quality Water (HQW) Zones shall be 7 calendar days with no exceptions for slope grades or lengths. High Quality Water Zones (HQW) Zones are defined by North Carolina Administrative Code 15A NCAC 04A.0105 (25). Temporary and permanent ground cover stabilization shall be achieved in accordance with the provisions in this contract and as directed.

## **SEEDING AND MULCHING:**

**(East)**

The kinds of seed and fertilizer, and the rates of application of seed, fertilizer, and limestone, shall be as stated below. During periods of overlapping dates, the kind of seed to be used shall be determined. All rates are in pounds per acre.

#### All Roadway Areas

<b>March 1 - August 31</b>		<b>September 1 - February 28</b>	
50#	Tall Fescue	50#	Tall Fescue
10#	Centipede	10#	Centipede
25#	Bermudagrass (hulled)	35#	Bermudagrass (unhulled)
500#	Fertilizer	500#	Fertilizer
4000#	Limestone	4000#	Limestone

#### Waste and Borrow Locations

<b>March 1 – August 31</b>		<b>September 1 - February 28</b>	
75#	Tall Fescue	75#	Tall Fescue
25#	Bermudagrass (hulled)	35#	Bermudagrass (unhulled)
500#	Fertilizer	500#	Fertilizer
4000#	Limestone	4000#	Limestone

Note: 50# of Bahiagrass may be substituted for either Centipede or Bermudagrass only upon Engineer's request.

#### Approved Tall Fescue Cultivars

06 Dust	Escalade	Justice	Serengeti
2 <sup>nd</sup> Millennium	Essential	Kalahari	Shelby
3 <sup>rd</sup> Millennium	Evergreen 2	Kitty Hawk 2000	Sheridan
Apache III	Falcon IV	Legitimate	Signia
Avenger	Falcon NG	Lexington	Silver Hawk
Barlexas	Falcon V	LSD	Sliverstar
Barlexas II	Faith	Magellan	Shenandoah Elite
Bar Fa	Fat Cat	Matador	Sidewinder
Barrera	Festnova	Millennium SRP	Skyline
Barrington	Fidelity	Monet	Solara
Barrobusto	Finelawn Elite	Mustang 4	Southern Choice II
Barvado	Finelawn Xpress	Ninja 2	Speedway
Biltmore	Finesse II	Ol' Glory	Spyder LS
Bingo	Firebird	Olympic Gold	Sunset Gold
Bizem	Firecracker LS	Padre	Taccoa
Blackwatch	Firenza	Patagonia	Tanzania
Blade Runner II	Five Point	Pedigree	Trio
Bonsai	Focus	Picasso	Tahoe II
Braveheart	Forte	Piedmont	Talladega
Bravo	Garrison	Plantation	Tarheel

Bullseye	Gazelle II	Proseeds 5301	Terrano
Cannavaro	Gold Medallion	Prospect	Titan ltd
Catalyst	Grande 3	Pure Gold	Titanium LS
Cayenne	Greenbrooks	Quest	Tracer
Cessane Rz	Greenkeeper	Raptor II	Traverse SRP
Chipper	Gremlin	Rebel Exeda	Tulsa Time
Cochise IV	Greystone	Rebel Sentry	Turbo
Constitution	Guardian 21	Rebel IV	Turbo RZ
Corgi	Guardian 41	Regiment II	Tuxedo RZ
Corona	Hemi	Regenerate	Ultimate
Coyote	Honky Tonk	Rendition	Venture
Darlington	Hot Rod	Rhambler 2 SRP	Umbrella
Davinci	Hunter	Rembrandt	Van Gogh
Desire	Inferno	Reunion	Watchdog
Dominion	Innovator	Riverside	Wolfpack II
Dynamic	Integrity	RNP	Xtremegreen
Dynasty	Jaguar 3	Rocket	
Endeavor	Jamboree	Scorpion	

On cut and fill slopes 2:1 or steeper Centipede shall be applied at the rate of 5 pounds per acre and add 20# of Sericea Lespedeza from January 1 - December 31.

Fertilizer shall be 10-20-20 analysis. A different analysis of fertilizer may be used provided the 1-2-2 ratio is maintained and the rate of application adjusted to provide the same amount of plant food as a 10-20-20 analysis and as directed.

### **Native Grass Seeding and Mulching**

**(East)**

Native Grass Seeding and Mulching shall be performed on the disturbed areas of wetlands and riparian areas, and adjacent to Stream Relocation construction within a 50 foot zone on both sides of the stream or depression, measured from top of stream bank or center of depression. The stream bank of the stream relocation shall be seeded by a method that does not alter the typical cross section of the stream bank. Native Grass Seeding and Mulching shall also be performed in the permanent soil reinforcement mat section of preformed scour holes, and in other areas as directed.

The kinds of seed and fertilizer, and the rates of application of seed, fertilizer, and limestone, shall be as stated below. During periods of overlapping dates, the kind of seed to be used shall be determined. All rates are in pounds per acre.

#### **March 1 - August 31**

18#	Creeping Red Fescue
6#	Indiangrass
8#	Little Bluestem
4#	Switchgrass
25#	Browntop Millet
500#	Fertilizer

#### **September 1 - February 28**

18#	Creeping Red Fescue
6#	Indiangrass
8#	Little Bluestem
4#	Switchgrass
35#	Rye Grain
500#	Fertilizer

4000# Limestone                      4000# Limestone

Approved Creeping Red Fescue Cultivars:

Aberdeen                      Boreal                      Epic                      Cindy Lou

Fertilizer shall be 10-20-20 analysis. A different analysis of fertilizer may be used provided the 1-2-2 ratio is maintained and the rate of application adjusted to provide the same amount of plant food as a 10-20-20 analysis and as directed.

Native Grass Seeding and Mulching shall be performed in accordance with Section 1660 of the *Standard Specifications* and vegetative cover sufficient to restrain erosion shall be installed immediately following grade establishment.

**Measurement and Payment**

Native Grass *Seeding and Mulching* will be measured and paid for in accordance with Article 1660-8 of the *Standard Specifications*.

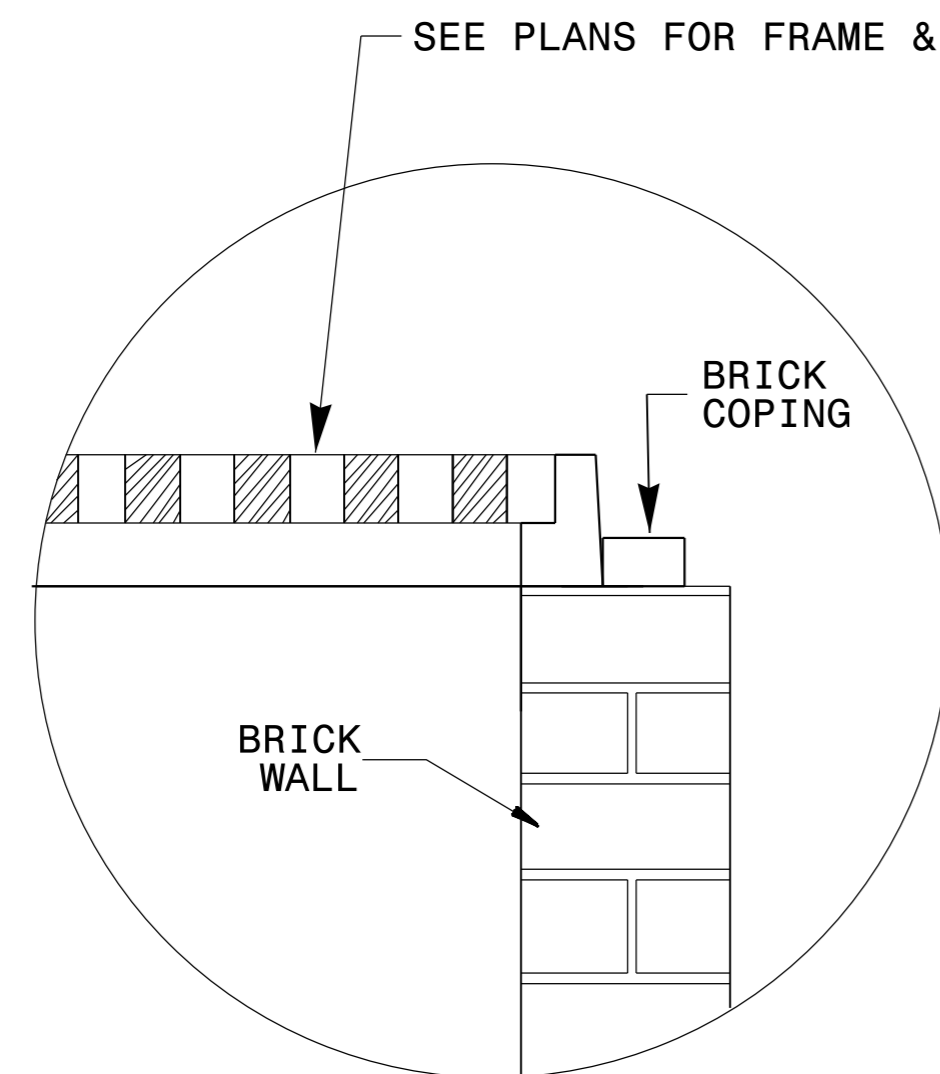

**GRATE PLACEMENT DETAIL**  
FOR DROP INLETS

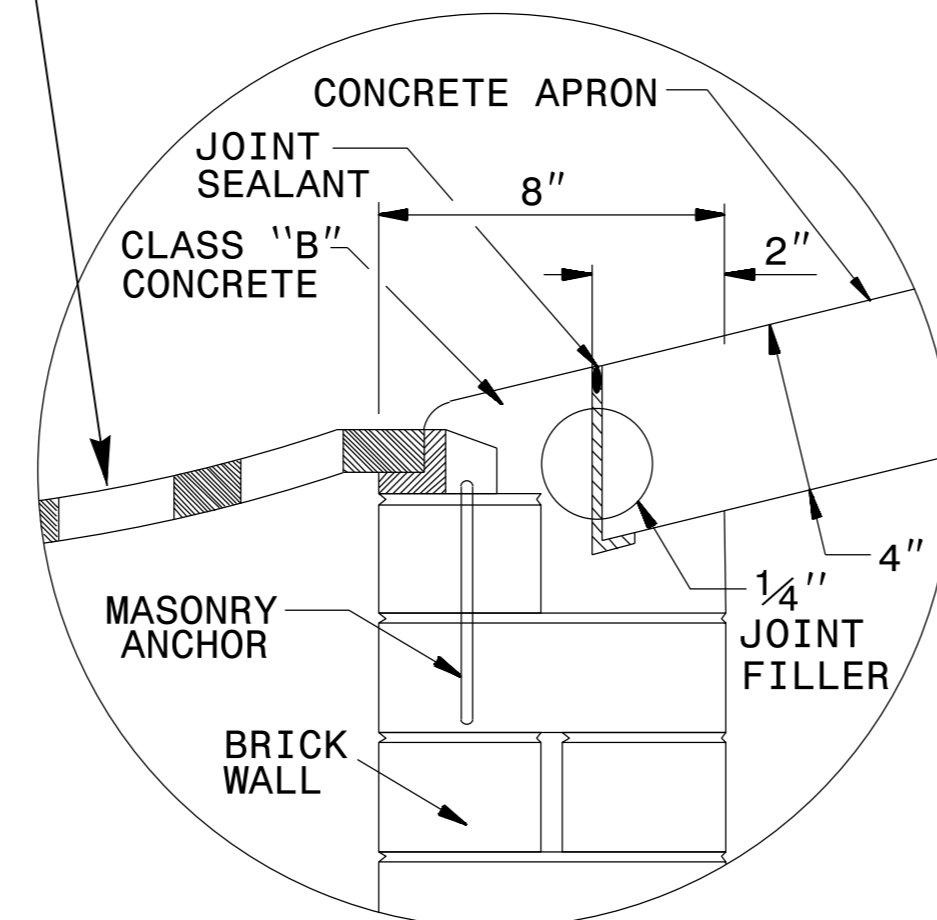

**GRATE PLACEMENT DETAIL**  
FOR GRATED DROP INLETS

**GENERAL NOTES:**

- CONSTRUCT IN ACCORDANCE WITH SECTION 859 OF THE STANDARD SPECIFICATIONS.
- USE CLASS B CONCRETE.
- THE DIMENSIONS FOR THE EXISTING BOXES ARE APPROXIMATE AND MAY VARY SLIGHTLY.
- JUMBO CONCRETE BRICK WILL BE PERMITTED. 4" CONCRETE BRICK OR 8" SOLID CONCRETE BLOCK ARE REQUIRED FOR DRAINAGE STRUCTURE.
- INCLUDE 18" CONCRETE APRON IN UNIT PRICE BID PER EACH, CONVERT EXISTING CATCH BASIN TO DROP INLET.
- SPECIAL DESIGN IS REQUIRED FOR USE UNDER PAVEMENT.
- CONFIRM DIMENSIONS ON EACH INDIVIDUAL FRAME & GRATE PROPOSAL.
- SEE STD. DRAWING 840.25 FOR MASONRY ANCHORAGE.

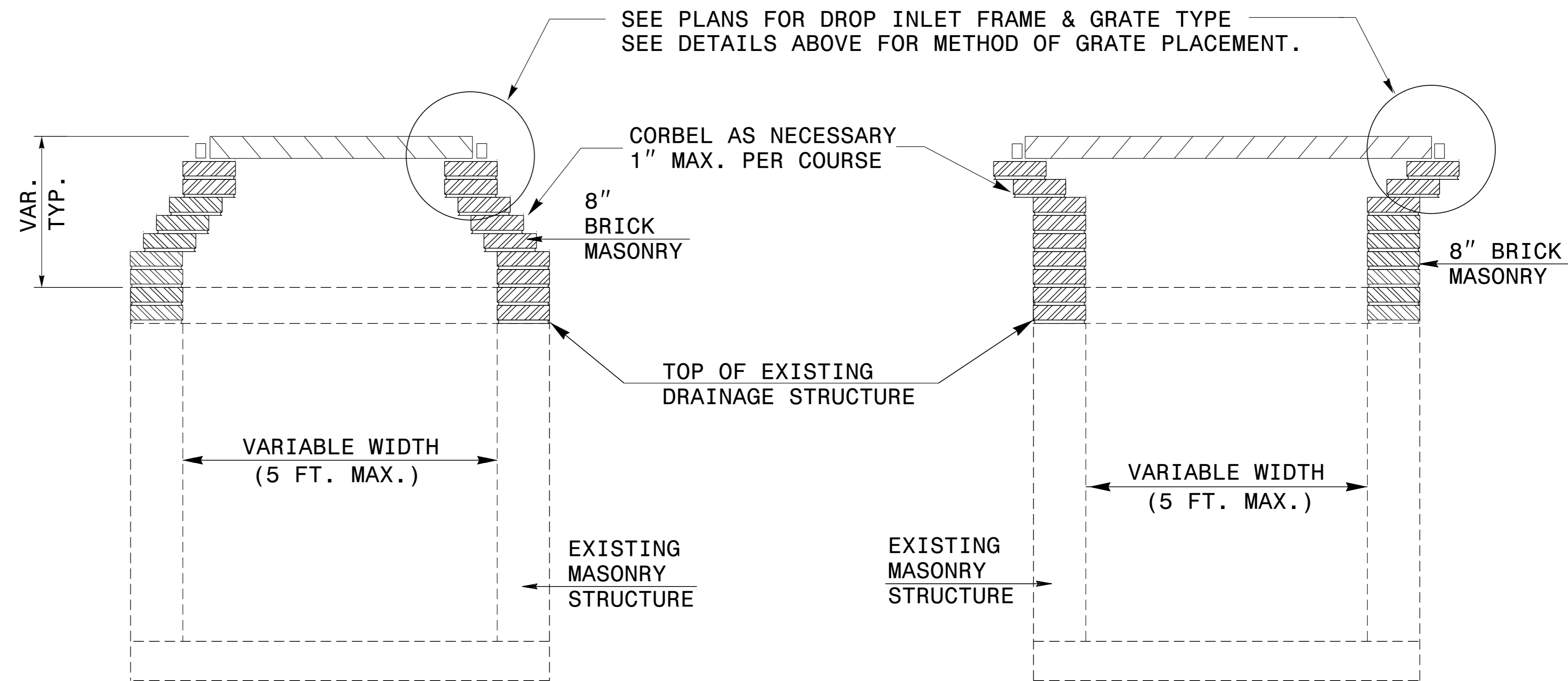

**TYPICAL SECTION**

**TYPICAL SECTION**

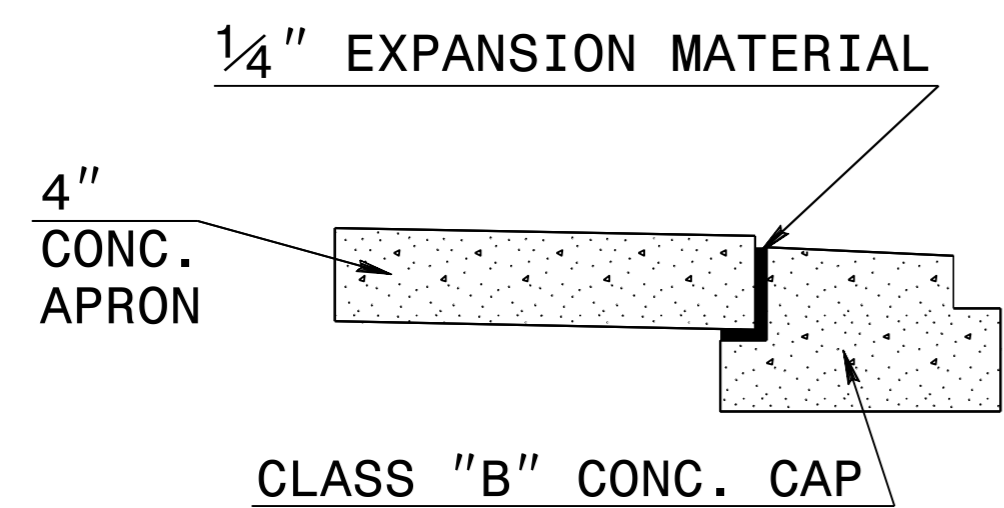

**EXPANSION JOINT DETAIL**

<b>CONTRACT STANDARDS AND DEVELOPMENT UNIT</b>	
Office 919-707-6950	FAX 919-250-4119
<b>DETAIL TO CONVERT EXISTING CATCH BASIN OR JUNCTION BOX TO DI OR 2-GI</b>	
ORIGINAL BY: T.S.S.	DATE: NOV. 1997
MODIFIED BY: T.S.S.	DATE: FEB. 2000
CHECKED BY:	DATE:
FILE SPEC.: s:usr/details/stand/cbtodi02.dgn	

C:\P\PROJECTS\CONCRETE\DRAWING\USER\NAME.DWG  
 TIME: 11:00 AM  
 DATE: 11/11/97

- 1 8.33% (12:1) MAX RAMP SLOPE
- 2 CROSS SLOPE: 2.00%
- 4 8.00% MAX CHANGE IN GRADE BETWEEN ROAD SURFACE AND DRIVEWAY

 PAY LIMITS FOR 1 CURB RAMP

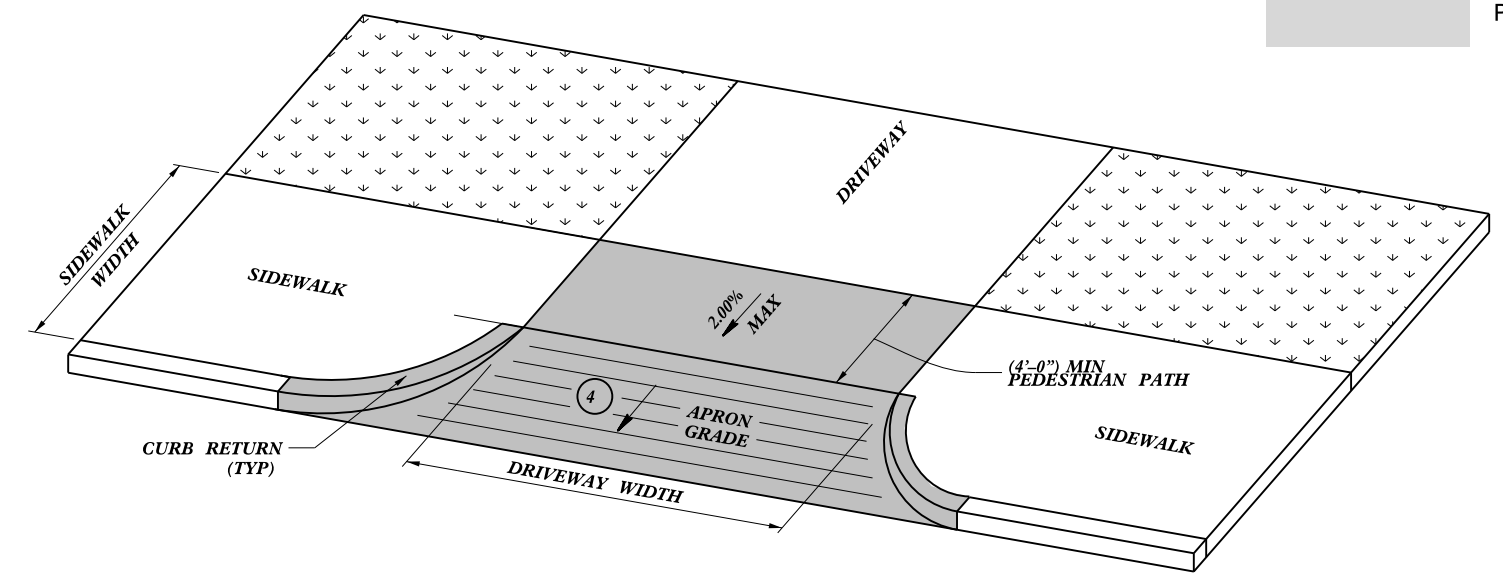

**DRIVEWAY APRON**  
**OPTION 1**

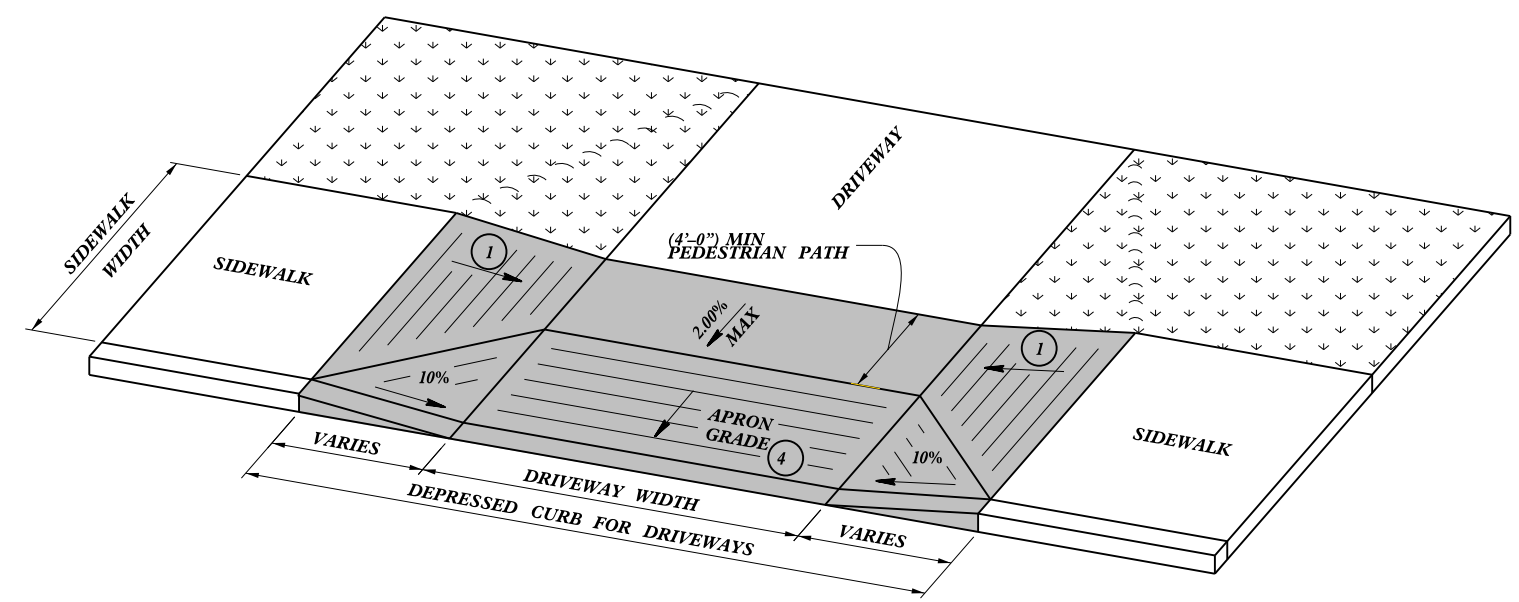

**DRIVEWAY APRON**  
**OPTION 2**

-SEE ROADWAY DETAIL DRAWING 848.05 FOR DETECTABLE WARNING SURFACE AND FOR RAMP NOTES.  
-SEE ROADWAY STANDARD DRAWING 848.02 FOR CONCRETE DRIVEWAYS.

<b>CONTRACT STANDARDS AND DEVELOPMENT UNIT</b>	
Office 919-707-6950	FAX 919-250-4119
<b>CURB RAMPS</b>	
@ DRIVEWAY OPENINGS	
ORIGINAL BY: J.S. HOWERTON	DATE: 7/7/11
MODIFIED BY:	DATE:
CHECKED BY:	DATE:
FILE SPEC: sstds/2012CurbRamp/CurbRampDetails.dwg	

5/14/99  
SYTIME  
C:\P\2012\STDS\CONSTRUCTION\SYTIME





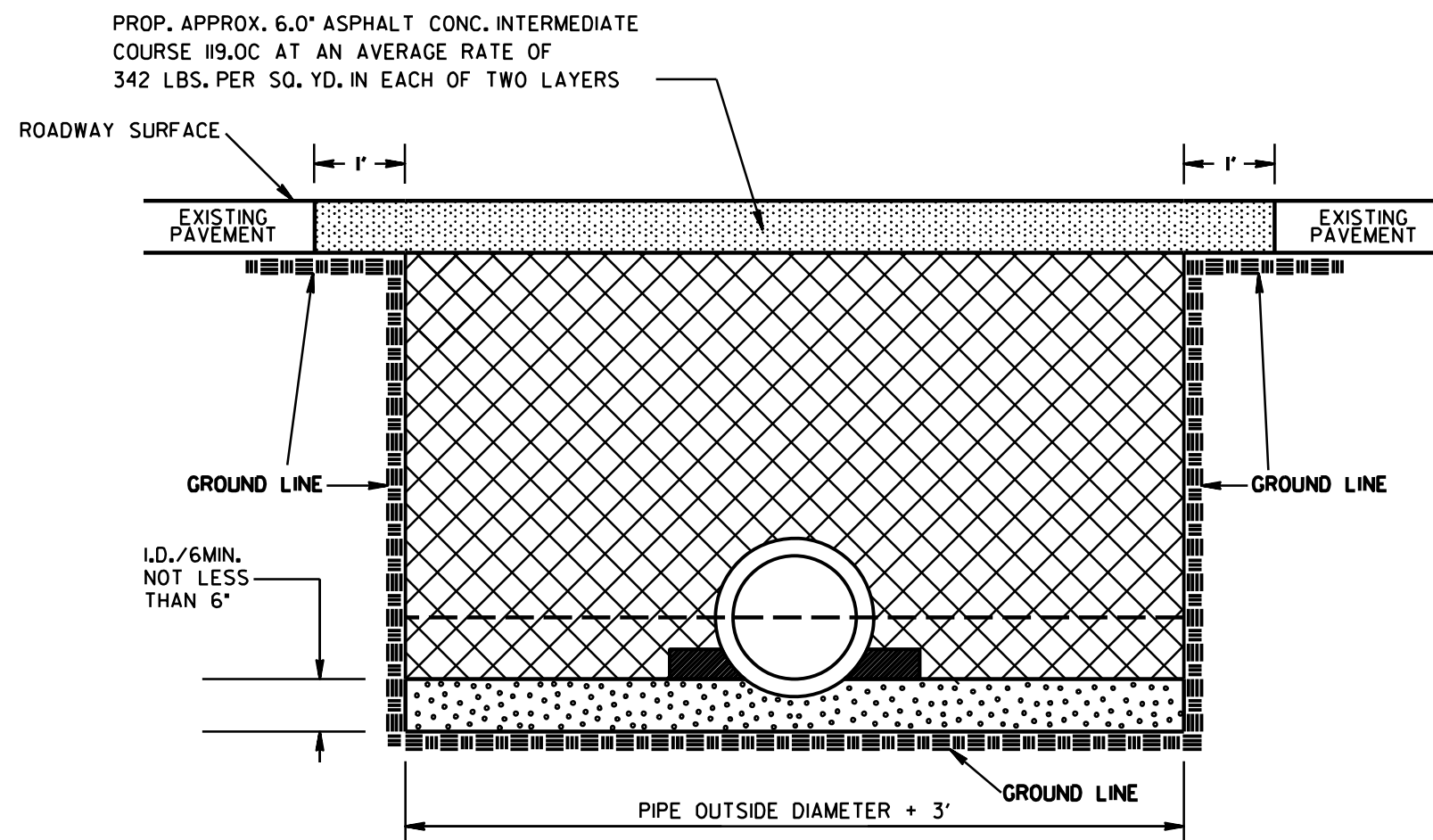

STATE	PROJECT NO.	SHEET NO.	TOTAL SHEETS
N.C.			
F.A. PROJECT NO.			

# PIPE INSTALLATION

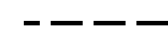

## NORMAL EARTH FOUNDATION

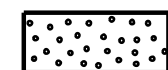
### GENERAL NOTES:

-  SPRINGLINE OF PIPE
-  TAKE CARE TO FULLY COMPACT HAUNCH ZONE OF PIPE BACKFILL
-  LOOSELY PLACED SELECT MATERIAL CLASS III OR CLASS II, TYPE I FOR PIPE BEDDING. LEAVE SECTION DIRECTLY BENEATH PIPE UNCOMPACTED AS PIPE SEATING AND BACKFILL WILL ACCOMPLISH COMPACTION. (78M STONE CAN BE USED IN LIEU OF SELECT MATERIAL AT THE DIRECTION OF THE ENGINEER)
-  78M STONE
-  UNDISTURBED EARTH MATERIAL

•PIPE JOINTS ARE REQUIRED TO BE WRAPPED AS PER SPECIAL PROVISION INCLUDED IN THE CONTRACT.

MAINTENANCE CONTRACT BACK FILL PIPE INSTALLATION		
SCALE	N/A	
DATE	5/2023	
DWG. BY	TGM	
DESIGN BY	ARF	
APPROVED	ARF	
		REVISIONS

ENGLISH STANDARD DRAWING FOR  
**MODIFIED CONCRETE MEDIAN APRON**

ENGLISH STANDARD DRAWING FOR  
**MODIFIED CONCRETE MEDIAN APRON**

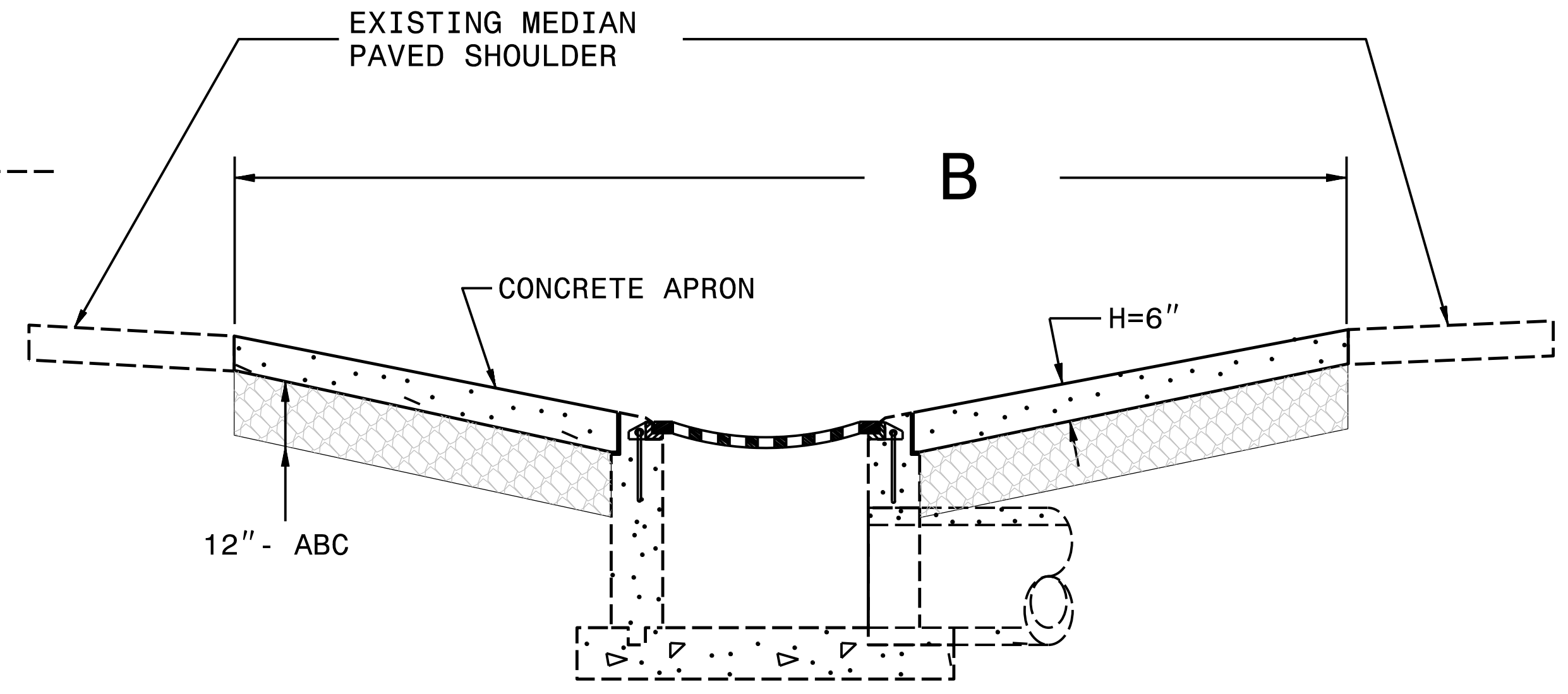
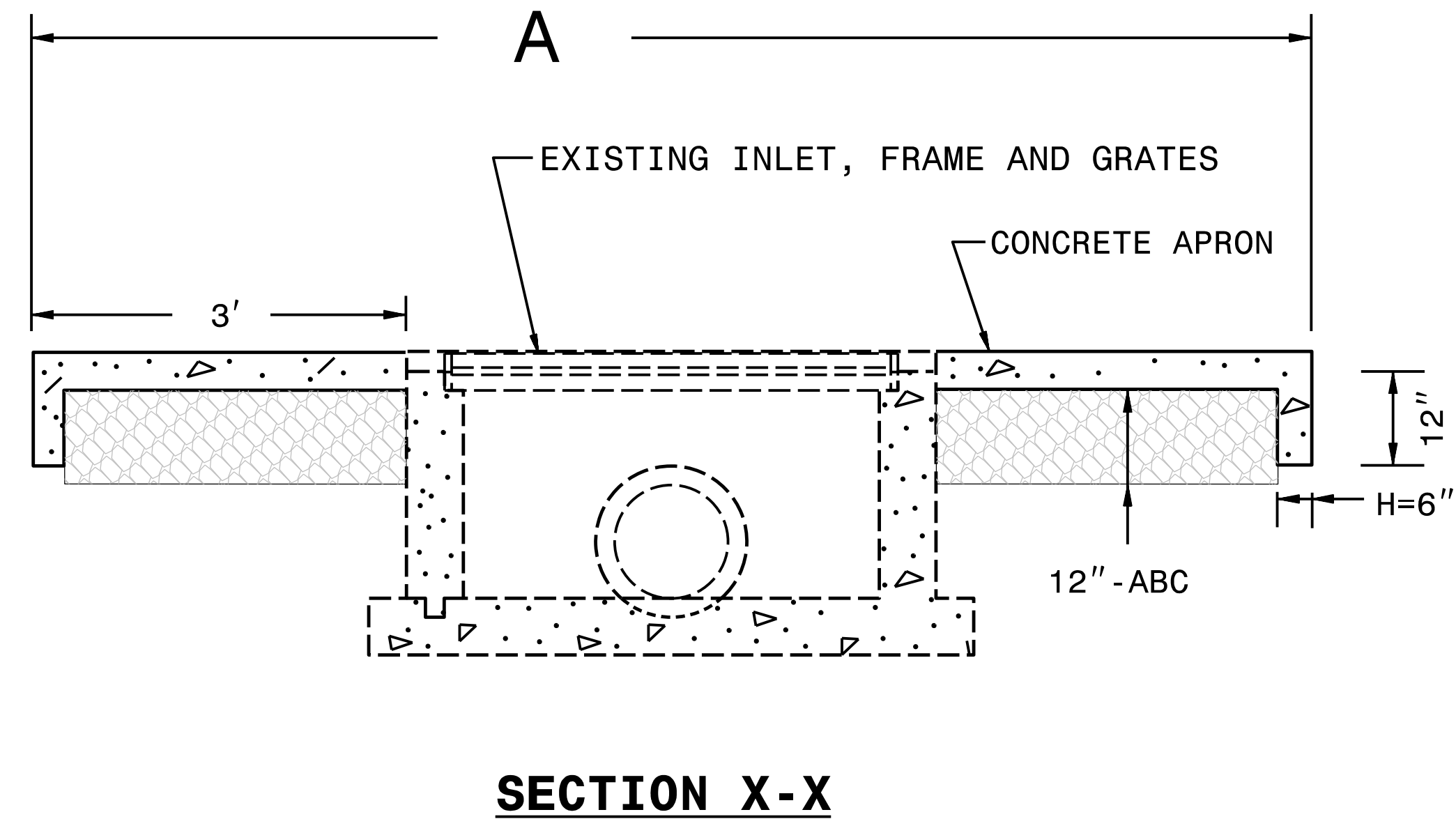
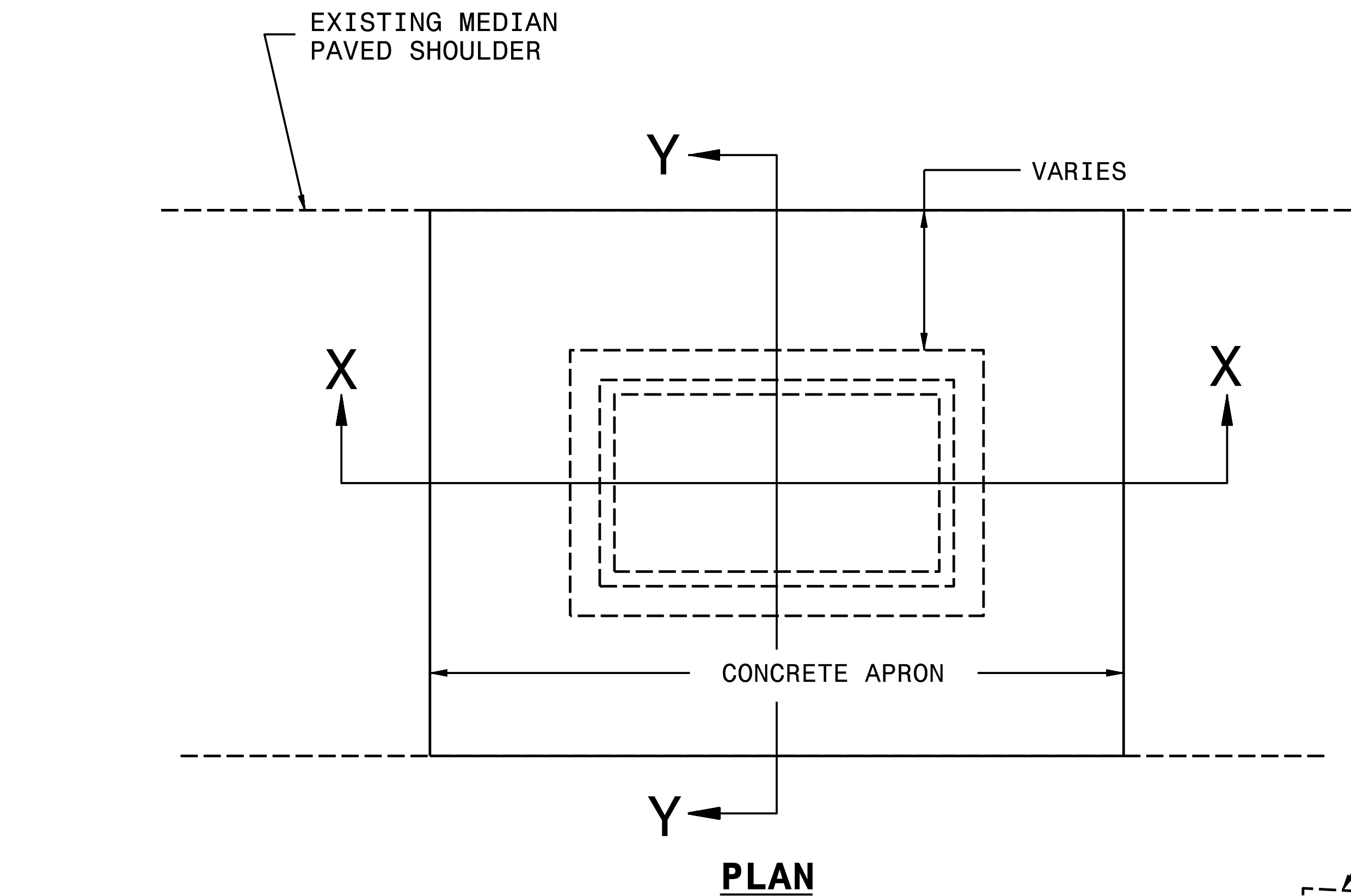

- GENERAL NOTES:
- CONCRETE APRONS SHALL TIE TO EXISTING EDGE OF PAVED MEDIAN SHOULDERS. MEDIAN WIDTHS VARY +/-24'.
  - USE CLASS "B" CONCRETE THROUGHOUT.
  - ABC (AGGREGATE BASE COURSE) TO BE APPLIED AND COMPACTED PER STD SPECS SECTION 520.
  - DRAWING NOT TO SCALE.

MINIMUM DIMENSIONS AND QUANTITIES FOR MEDIAN CONCRETE APRON					
SPAN	WIDTH	THICKNESS	CONC CY	ABC TONS	NOTES
A	B VARIES	H			
10'-8"	+/- 24'	6"	4.6	12	
QUANTITY= 17			TOTALS:	78	204

STATE OF  
NORTH CAROLINA  
DEPT. OF TRANSPORTATION  
DIVISION OF HIGHWAYS  
RALEIGH, N.C.

ENGLISH DETAIL DRAWING FOR  
**MODIFIED CONCRETE FLUME**  
WITH CONCRETE OR RIP-RAP DITCH

STATE OF  
NORTH CAROLINA  
DEPT. OF TRANSPORTATION  
DIVISION OF HIGHWAYS  
RALEIGH, N.C.

ENGLISH DETAIL DRAWING FOR  
**MODIFIED CONCRETE FLUME**  
WITH CONCRETE OR RIP-RAP DITCH

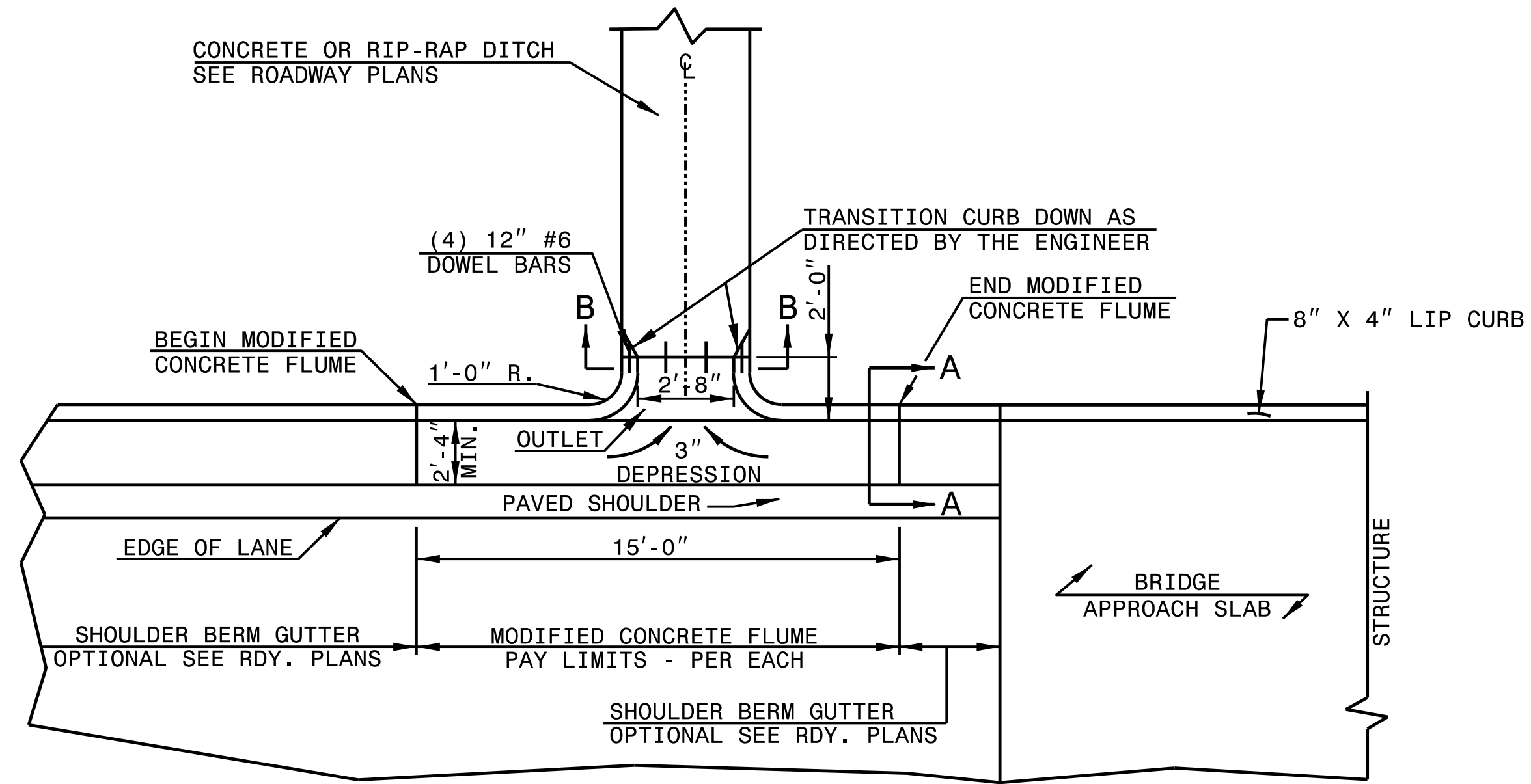

PLAN VIEW

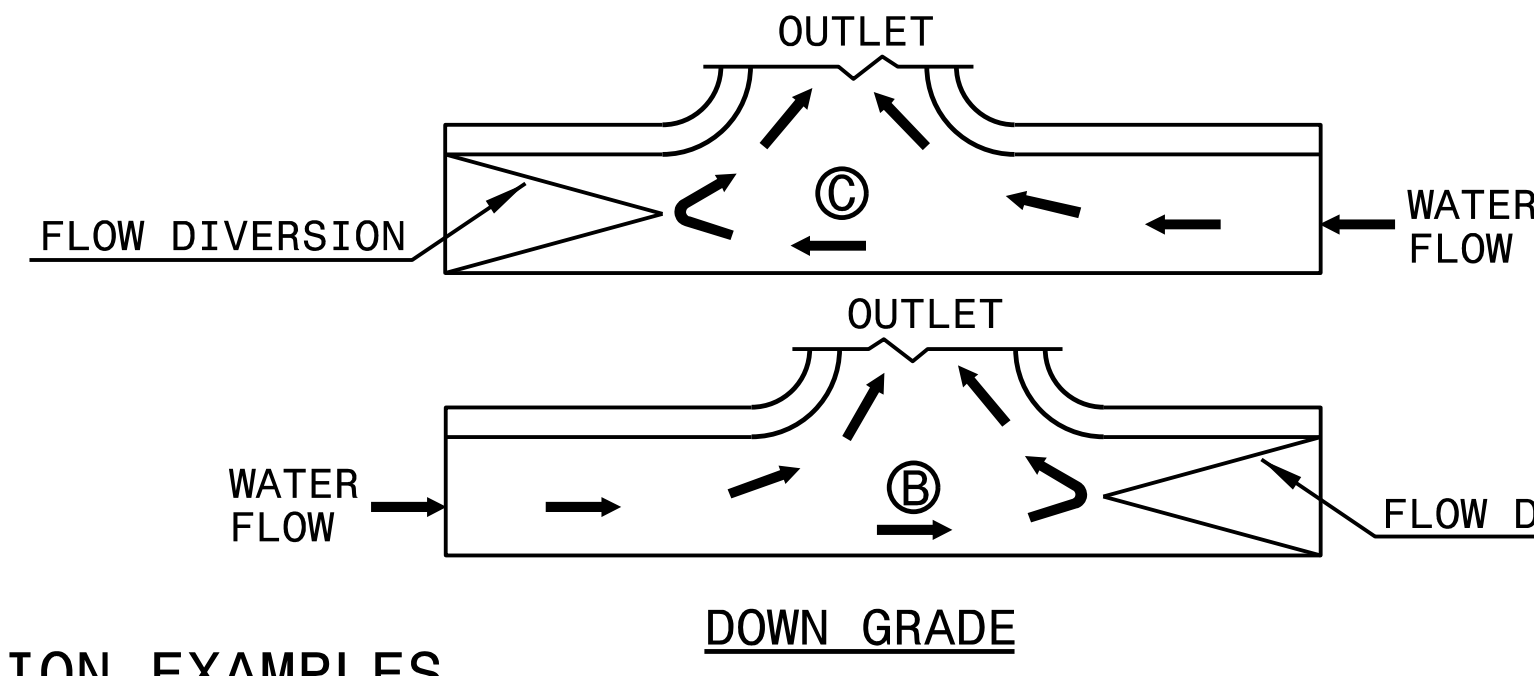
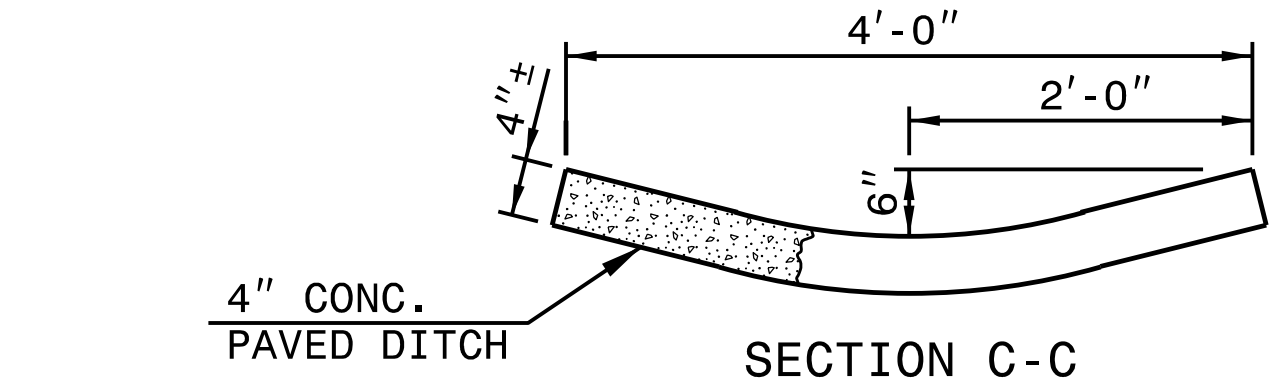
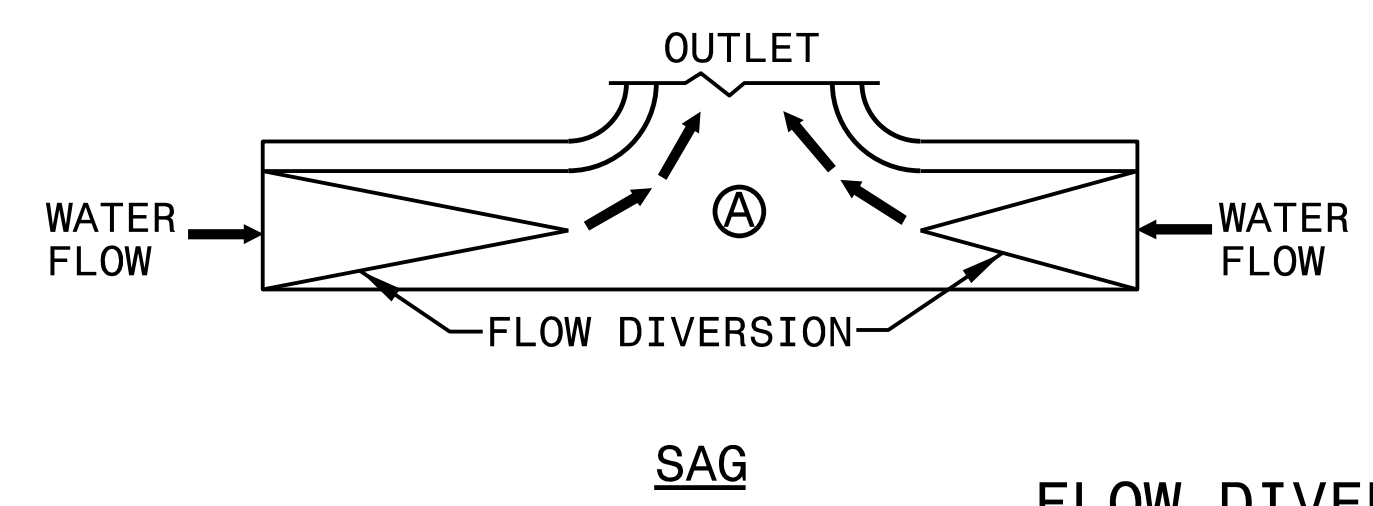
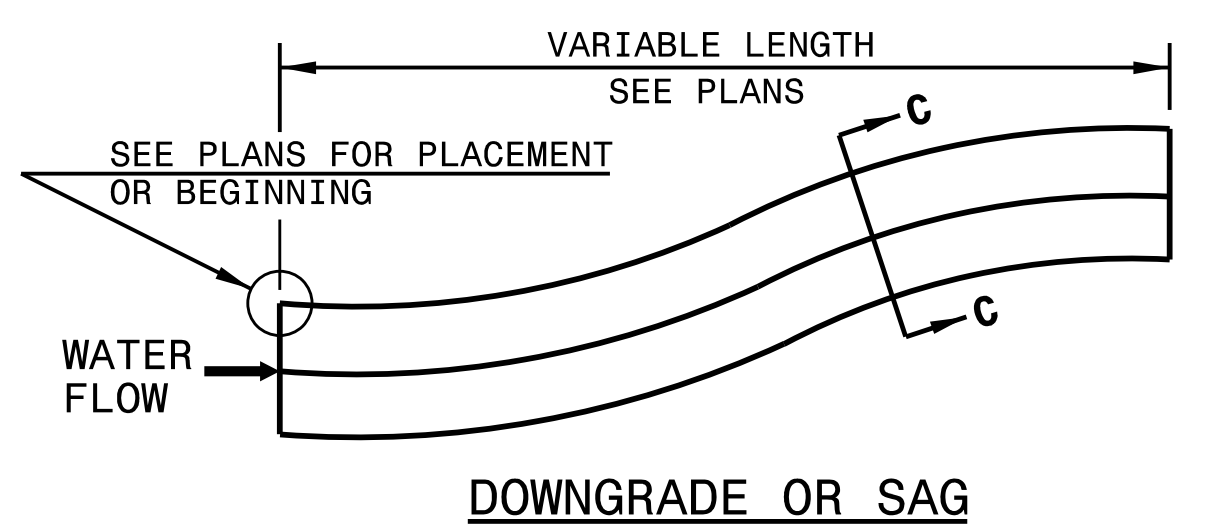

FLOW DIVERSION EXAMPLES

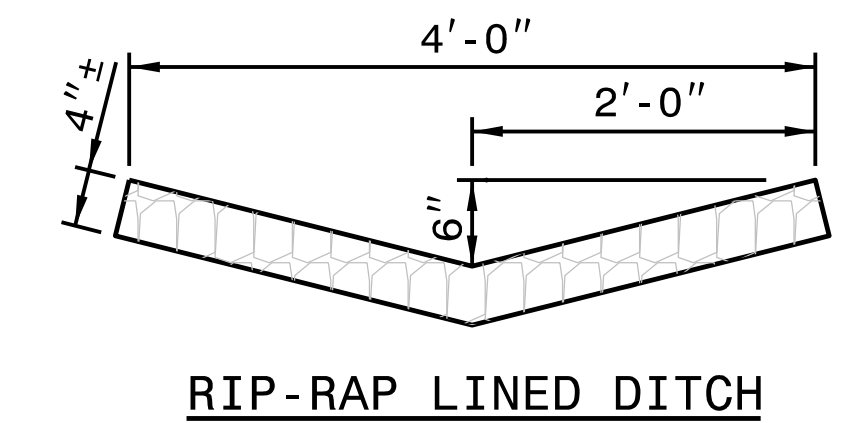
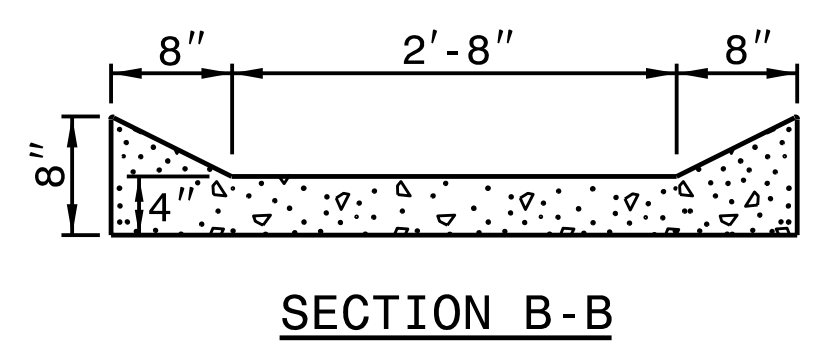
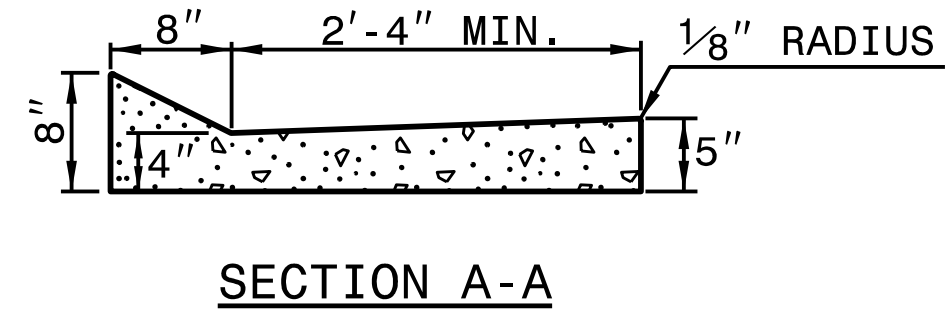

- NOTES:
- CONSTRUCT MODIFIED CONCRETE FLUME AND SHOULDER BERM GUTTER IN ACCORDANCE WITH THIS DETAIL.
  - CONSTRUCT CONCRETE DITCH IN ACCORDANCE WITH STD. DWG. NO. 850.01.
  - CONSTRUCT RIP RAP LINED DITCH IN ACCORDANCE WITH THIS DETAIL, IF CALLED FOR IN PLANS.
  - CONCRETE OR RIP RAP LINED DITCH SHALL BE THE TYPE AND LENGTH SPECIFIED BY THE ROADWAY PLANS. THE DITCH SHALL TERMINATE AS SHOWN ON THE PLANS. IF NO TERMINATION IS INDICATED PLACE RIP-RAP AT THE END OF THE DITCH AS INDICATED BY STD. DWG. 876.02 FOR AN 18" PIPE. TRANSITIONS FROM THE DITCH TO TERMINATION SHALL BE AS DIRECTED BY THE ENGINEER.
  - MODIFICATIONS SHALL BE AS DICTATED BY SITE CONDITIONS AND DIRECTED BY THE ENGINEER.

SHEET 1 OF 1  
MODFLMDTCH

SHEET 1 OF 1  
MODFLMDTCH

PROJECT SERVICES UNIT  
STANDARDS AND SPECIAL DESIGN  
Office 919-250-4128 FAX 919-250-4119

**SEE PLATE FOR TITLE**

ORIGINAL BY: E.E. Ward DATE: Apr. 2002  
 MODIFIED BY: E.E. Ward DATE: July 2004  
 CHECKED BY: DATE:  
 FILE SPEC.:

\$\$\$ TIME \$\$\$  
 \$\$\$ COST \$\$\$  
 \$\$\$ PERMITS \$\$\$  
 \$\$\$ DESIGN \$\$\$  
 \$\$\$ CONSTRUCTION \$\$\$

**LISTING OF MBE/WBE SUBCONTRACTORS**

Sheet of

Firm Name and Address	Circle One	Item No.	Item Description	* Agreed upon Unit Price	** Dollar Volume of Item
<b>Name</b>  Address	MBE  WBE				
<b>Name</b>  Address	MBE  WBE				
<b>Name</b>  Address	MBE  WBE				
<b>Name</b>  Address	MBE  WBE				
<b>Name</b>  Address	MBE  WBE				
<b>Name</b>  Address	MBE  WBE				

\* The Dollar Volume shown in this column shall be the Actual Price Agreed Upon by the Prime Contractor and the MBE/WBE subcontractor, and these prices will be used to determine the percentage of the MBE/WBE participation in the contract.

\*\* Dollar Volume of MBE/WBE Subcontractor Percentage of Total Contract Bid Price:

*If firm is a Material Supplier Only, show Dollar Volume as 60% of Agreed Upon Amount from Letter of Intent.*

*If firm is a Manufacturer, show Dollar Volume as 100% of Agreed Upon Amount from Letter of Intent.*

**LISTING OF MBE/WBE SUBCONTRACTORS**

Sheet \_\_\_\_\_ of \_\_\_\_\_

Firm Name and Address	Circle One	Item No.	Item Description	* Agreed upon Unit Price	** Dollar Volume of Item
Name  Address	MBE  WBE				
Name  Address	MBE  WBE				
Name  Address	MBE  WBE				
Name  Address	MBE  WBE				
Name  Address	MBE  WBE				

**\*\* Dollar Volume of MBE Subcontractor** \$ \_\_\_\_\_

**MBE Percentage of Total Contract Bid Price** \_\_\_\_\_%

**\*\* Dollar Volume of WBE Subcontractor** \$ \_\_\_\_\_

**WBE Percentage of Total Contract Bid Price** \_\_\_\_\_%

**\*The Dollar Volume shown in this column shall be the Actual Price Agreed Upon by the Prime Contractor and the MBE/WBE subcontractor, and these prices will be used to determine the percentage of the MBE/WBE participation in the contract.**

**\*\* Dollar Volume of MBE/WBE Subcontractor Percentage of Total Contract Bid Price.**

**If firm is a Material Supplier Only, show Dollar Volume as 60% of Agreed Upon Amount from Letter of Intent.**

**If firm is a Manufacturer, show Dollar Volume as 100% of Agreed Upon Amount from Letter of Intent.**

ADDENDA

ADDENDUM #1

I, \_\_\_\_\_  
(SIGNATURE)

representing \_\_\_\_\_

Acknowledge receipt of Addendum #1.

ADDENDUM #2

I, \_\_\_\_\_  
(SIGNATURE)

representing \_\_\_\_\_

Acknowledge receipt of Addendum #2.

ADDENDUM #3

I, \_\_\_\_\_  
(SIGNATURE)

representing \_\_\_\_\_

Acknowledge receipt of Addendum #3.

**\*AWARD LIMITS ON MULTIPLE PROJECTS\***

It is the desire of the Proposer to be awarded contracts, the value of which will not exceed a total of \$ \_\_\_\_\_, for those projects indicated below on which bids are being opened on the same date as shown in the Proposal Form. Individual projects shall be indicated by placing the project number and county in the appropriate place below. Projects not selected will not be subject to an award limit.

\_\_\_\_\_  
(Project Number)

\_\_\_\_\_  
(County)

\_\_\_\_\_  
(Project Number)

\_\_\_\_\_  
(County)

\_\_\_\_\_  
(Project Number)

\_\_\_\_\_  
(County)

\_\_\_\_\_  
(Project Number)

\_\_\_\_\_  
(County)

\*If a Proposer desires to limit the total amount of work awarded to him in this letting, he shall state such limit in the space provided above in the second line of this form.

It is agreed that in the event that I am (we are) the successful bidder on indicated projects, the total value of which is more that the above stipulated award limits, the Board of Transportation will award me (us) projects from among those indicated which have a total value not exceeding the award limit and which will result in the best advantage to the Department of Transportation.

\_\_\_\_\_  
\*\*Signature of Authorized Person

\*\*Only those persons authorized to sign bids under Subarticle 102-8(A)(12) shall be authorized to sign this form.

**NON-COLLUSION, DEBARMENT AND GIFT BAN CERTIFICATION**

**CORPORATION**

The prequalified bidder being duly sworn, solemnly swears (or affirms) that neither he, nor any official, agent or employee has entered into any agreement, participated in any collusion, or otherwise taken any action which is in restraint of free competitive bidding in connection with any bid or contract, that the prequalified bidder has not been convicted of violating *N.C.G.S. §133-24* within the last three years, and that the prequalified bidder intends to do the work with his own bona fide employees or subcontractors and will not bid for the benefit of another contractor.

By submitting this non-collusion, debarment and gift ban certification, the Contractor is attesting his status under penalty of perjury under the laws of the United States in accordance with the Debarment Certification attached, provided that the Debarment Certification also includes any required statements concerning exceptions that are applicable.

*N.C.G.S. §133-32* and Executive Order 24 prohibit the offer to, or acceptance by, any State Employee of any gift from anyone with a contract with the State, or from any person seeking to do business with the State. By execution of any response in this procurement, you attest, for your entire organization and its employees or agents, that you are not aware that any such gift has been offered, accepted, or promised by any employees of your organization.

**SIGNATURE OF PREQUALIFIED BIDDER**

\_\_\_\_\_  
Full name of Corporation

\_\_\_\_\_  
Address as Prequalified

Attest \_\_\_\_\_  
Secretary/Assistant Secretary  
*(Select appropriate title)*

By \_\_\_\_\_  
President/Vice President/Assistant Vice President  
*(Select appropriate title)*

\_\_\_\_\_  
Print or Type Signer's name

\_\_\_\_\_  
Print or Type Signer's name





**NON-COLLUSION, DEBARMENT AND GIFT BAN CERTIFICATION**

**PARTNERSHIP**

The prequalified bidder, being duly sworn, solemnly swears (or affirms) that neither he, nor any official, agent or employee has entered into any agreement, participated in any collusion, or otherwise taken any action which is in restraint of free competitive bidding in connection with any bid or contract, that the prequalified bidder has not been convicted of violating *N.C.G.S. § 133-24* within the last three years, and that the prequalified bidder intends to do the work with its own bona fide employees or subcontractors and will not bid for the benefit of another contractor.

By submitting this non-collusion, debarment and gift ban certification, the Contractor is attesting his status under penalty of perjury under the laws of the United States in accordance with the Debarment Certification attached, provided that the Debarment Certification also includes any required statements concerning exceptions that are applicable.

*N.C.G.S. § 133-32* and Executive Order 24 prohibit the offer to, or acceptance by, any State Employee of any gift from anyone with a contract with the State, or from any person seeking to do business with the State. By execution of any response in this procurement, you attest, for your entire organization and its employees or agents, that you are not aware that any such gift has been offered, accepted, or promised by any employees of your organization.

**SIGNATURE OF PREQUALIFIED BIDDER**

\_\_\_\_\_

Full Name of  
Partnership

\_\_\_\_\_

Address as  
Prequalified

\_\_\_\_\_  
Signature of Witness

\_\_\_\_\_  
Signature of Partner

\_\_\_\_\_  
Print or Type Signer's Name

\_\_\_\_\_  
Print or Type Signer's Name

**NON-COLLUSION, DEBARMENT AND GIFT BAN CERTIFICATION**

**LIMITED LIABILITY COMPANY**

The prequalified bidder, being duly sworn, solemnly swears (or affirms) that neither he, nor any official, agent or employee has entered into any agreement, participated in any collusion, or otherwise taken any action which is in restraint of free competitive bidding in connection with any bid or contract, that the prequalified bidder has not been convicted of violating *N.C.G.S. § 133-24* within the last three years, and that the prequalified bidder intends to do the work with its own bona fide employees or subcontractors and will not bid for the benefit of another contractor.

By submitting this non-collusion, debarment and gift ban certification, the Contractor is attesting his status under penalty of perjury under the laws of the United States in accordance with the Debarment Certification attached, provided that the Debarment Certification also includes any required statements concerning exceptions that are applicable.

*N.C.G.S. § 133-32* and Executive Order 24 prohibit the offer to, or acceptance by, any State Employee of any gift from anyone with a contract with the State, or from any person seeking to do business with the State. By execution of any response in this procurement, you attest, for your entire organization and its employees or agents, that you are not aware that any such gift has been offered, accepted, or promised by any employees of your organization.

**SIGNATURE OF PREQUALIFIED BIDDER**

---

Full Name of Firm

---

Address as Prequalified

---

Signature of Witness

---

Signature of Member/Manager/Authorized Agent  
*(Select appropriate Title)*

---

Print or Type Signer's Name

---

Print or Type Signer's Name

**NON-COLLUSION, DEBARMENT AND GIFT BAN CERTIFICATION**

**JOINT VENTURE (2) or (3)**

The prequalified bidder, being duly sworn, solemnly swears (or affirms) that neither he, nor any official, agent or employee has entered into any agreement, participated in any collusion, or otherwise taken any action which is in restraint of free competitive bidding in connection with any bid or contract, that the prequalified bidder has not been convicted of violating N.C.G.S. § 133-24 within the last three years, and that the prequalified bidder intends to do the work with its own bona fide employees or subcontractors and will not bid for the benefit of another contractor.

By submitting this non-collusion, debarment and gift ban certification, the Contractor is attesting his status under penalty of perjury under the laws of the United States in accordance with the Debarment Certification attached, provided that the Debarment Certification also includes any required statements concerning exceptions that are applicable.

N.C.G.S. § 133-32 and Executive Order 24 prohibit the offer to, or acceptance by, any State Employee of any gift from anyone with a contract with the State, or from any person seeking to do business with the State. By execution of any response in this procurement, you attest, for your entire organization and its employees or agents, that you are not aware that any such gift has been offered, accepted, or promised by any employees of your organization.

**SIGNATURE OF PREQUALIFIED BIDDER**

Instructions: **2 Joint Venturers** Fill in lines (1), (2) and (3) and execute. **3 Joint Venturers** Fill in lines (1), (2), (3) and (4) and execute. On Line (1), fill in the name of the Joint Venture Company. On Line (2), fill in the name of one of the joint venturers and execute below in the appropriate manner. On Line (3), print or type the name of the other joint venturer and execute below in the appropriate manner. On Line (4), fill in the name of the third joint venturer, if applicable and execute below in the appropriate manner.

(1) \_\_\_\_\_  
Name of Joint Venture

(2) \_\_\_\_\_  
Name of Contractor

\_\_\_\_\_  
Address as Prequalified

\_\_\_\_\_  
Signature of Witness or Attest

 BY 

\_\_\_\_\_  
Signature of Contractor

\_\_\_\_\_  
Print or Type Signer's Name

 AND 

\_\_\_\_\_  
Print or Type Signer's Name

*If Corporation, affix Corporate Seal*

(3) \_\_\_\_\_  
Name of Contractor

\_\_\_\_\_  
Address as Prequalified

\_\_\_\_\_  
Signature of Witness or Attest

 BY 

\_\_\_\_\_  
Signature of Contractor

\_\_\_\_\_  
Print or Type Signer's Name

 AND 

\_\_\_\_\_  
Print or Type Signer's Name

*If Corporation, affix Corporate Seal*

(4) \_\_\_\_\_  
Name of Contractor

\_\_\_\_\_  
Address as Prequalified

\_\_\_\_\_  
Signature of Witness or Attest

 BY 

\_\_\_\_\_  
Signature of Contractor

\_\_\_\_\_  
Print or Type Signer's Name

 AND 

\_\_\_\_\_  
Print or Type Signer's Name

*If Corporation, affix Corporate Seal*

CORPORATE SEAL(S)

**NON-COLLUSION, DEBARMENT AND GIFT BAN CERTIFICATION**

**INDIVIDUAL DOING BUSINESS UNDER A FIRM NAME**

The prequalified bidder, being duly sworn, solemnly swears (or affirms) that neither he, nor any official, agent or employee has entered into any agreement, participated in any collusion, or otherwise taken any action which is in restraint of free competitive bidding in connection with any bid or contract, that the prequalified bidder has not been convicted of violating *N.C.G.S. § 133-24* within the last three years, and that the prequalified bidder intends to do the work with its own bona fide employees or subcontractors and will not bid for the benefit of another contractor.

By submitting this non-collusion, debarment and gift ban certification, the Contractor is attesting his status under penalty of perjury under the laws of the United States in accordance with the Debarment Certification attached, provided that the Debarment Certification also includes any required statements concerning exceptions that are applicable.

*N.C.G.S. § 133-32* and Executive Order 24 prohibit the offer to, or acceptance by, any State Employee of any gift from anyone with a contract with the State, or from any person seeking to do business with the State. By execution of any response in this procurement, you attest, for your entire organization and its employees or agents, that you are not aware that any such gift has been offered, accepted, or promised by any employees of your organization.

**SIGNATURE OF PREQUALIFIED BIDDER**

Name of Prequalified Bidder

\_\_\_\_\_
Individual Name

Trading and Doing Business As

\_\_\_\_\_
Full name of Firm

\_\_\_\_\_
Address as Prequalified

\_\_\_\_\_
Signature of Witness

\_\_\_\_\_
Signature of Prequalified Bidder, Individual

\_\_\_\_\_
Print or Type Signer's Name

\_\_\_\_\_
Print or Type Signer's Name

**NON-COLLUSION, DEBARMENT GIFT BAN CERTIFICATION**

**INDIVIDUAL DOING BUSINESS IN HIS OWN NAME**

The prequalified bidder, being duly sworn, solemnly swears (or affirms) that neither he, nor any official, agent or employee has entered into any agreement, participated in any collusion, or otherwise taken any action which is in restraint of free competitive bidding in connection with any bid or contract, that the prequalified bidder has not been convicted of violating *N.C.G.S. § 133-24* within the last three years, and that the prequalified bidder intends to do the work with its own bona fide employees or subcontractors and will not bid for the benefit of another contractor.

By submitting this non-collusion, debarment and gift ban certification, the Contractor is attesting his status under penalty of perjury under the laws of the United States in accordance with the Debarment Certification attached, provided that the Debarment Certification also includes any required statements concerning exceptions that are applicable.

*N.C.G.S. § 133-32* and Executive Order 24 prohibit the offer to, or acceptance by, any State Employee of any gift from anyone with a contract with the State, or from any person seeking to do business with the State. By execution of any response in this procurement, you attest, for your entire organization and its employees or agents, that you are not aware that any such gift has been offered, accepted, or promised by any employees of your organization.

**SIGNATURE OF PREQUALIFIED BIDDER**

Name of Prequalified Bidder \_\_\_\_\_  
Print or Type Name

\_\_\_\_\_  
Address as Prequalified

\_\_\_\_\_  
Signature of Prequalified Bidder, Individually

\_\_\_\_\_  
Print or Type Signer's Name

\_\_\_\_\_  
Signature of Witness

\_\_\_\_\_  
Print or Type Signer's name

**DEBARMENT CERTIFICATION**

Conditions for certification:

1. The prequalified bidder shall provide immediate written notice to the Department if at any time the bidder learns that his certification was erroneous when he submitted his debarment certification or explanation that is file with the Department, or has become erroneous because of changed circumstances.
2. The terms *covered transaction, debarred, suspended, ineligible, lower tier covered transaction, participant, person, primary covered transaction, principal, proposal, and voluntarily excluded*, as used in this provision, have the meanings set out in the Definitions and Coverage sections of the rules implementing Executive Order 12549. A copy of the Federal Rules requiring this certification and detailing the definitions and coverages may be obtained from the Contract Officer of the Department.
3. The prequalified bidder agrees by submitting this form, that he will not knowingly enter into any lower tier covered transaction with a person who is debarred, suspended, declared ineligible, or voluntarily excluded from participation in NCDOT contracts, unless authorized by the Department.
4. For Federal Aid projects, the prequalified bidder further agrees that by submitting this form he will include the Federal-Aid Provision titled *Required Contract Provisions Federal-Aid Construction Contract (Form FHWA PR 1273)* provided by the Department, without subsequent modification, in all lower tier covered transactions.
5. The prequalified bidder may rely upon a certification of a participant in a lower tier covered transaction that he is not debarred, suspended, ineligible, or voluntarily excluded from the covered transaction, unless he knows that the certification is erroneous. The bidder may decide the method and frequency by which he will determine the eligibility of his subcontractors.
6. Nothing contained in the foregoing shall be construed to require establishment of a system of records in order to render in good faith the certification required by this provision. The knowledge and information of a participant is not required to exceed that which is normally possessed by a prudent person in the ordinary course of business dealings.
7. Except as authorized in paragraph 6 herein, the Department may terminate any contract if the bidder knowingly enters into a lower tier covered transaction with a person who is suspended, debarred, ineligible, or voluntarily excluded from participation in this transaction, in addition to other remedies available by the Federal Government.

**DEBARMENT CERTIFICATION**

The prequalified bidder certifies to the best of his knowledge and belief, that he and his principals:

- a. Are not presently debarred, suspended, proposed for debarment, declared ineligible, or voluntarily excluded from covered transactions by any Federal department or agency;
- b. Have not within a three-year period preceding this proposal been convicted of or had a civil judgment rendered against them for commission of fraud or a criminal offense in connection with obtaining, attempting to obtain, or performing a public (Federal, State or local) transaction or contract under a public transaction; violation of Federal or State antitrust statutes or commission of embezzlement, theft, forgery, bribery, falsification or destruction of records; making false statements; or receiving stolen property;
- c. Are not presently indicted for or otherwise criminally or civilly charged by a governmental entity (Federal, State or local) with commission of any of the offenses enumerated in paragraph b. of this certification; and
- d. Have not within a three-year period preceding this proposal had one or more public transactions (Federal, State or local) terminated for cause or default.
- e. Will submit a revised Debarment Certification immediately if his status changes and will show in his bid proposal an explanation for the change in status.

If the prequalified bidder cannot certify that he is not debarred, he shall provide an explanation with this submittal. An explanation will not necessarily result in denial of participation in a contract.

Failure to submit a non-collusion affidavit and debarment certification will result in the prequalified bidder's bid being considered non-responsive.

Check here if an explanation is attached to this certification.

**North Carolina Department of Transportation  
PURCHASE ORDER CONTRACT BID FORM**

**Work Order:** Various

**Description:** Annual Needs for Miscellaneous Concrete for District 3

**County:** Franklin, Vance, and Warren

ITEM	SECT	DESCRIPTION	QTY	UNIT	UNIT PRICE (\$)	AMOUNT BID (\$)
1	SP	EMERGENCY MOBILIZATION	3	EA		
2	225	UNCLASSIFIED EXCAVATION	1000	CY		
3	230	BORROW EXCAVATION	140	CY		
4	270	GEOTEXTILE FOR SOIL STABILIZATION	350	SY		
5	300	FOUNDATION CONDITIONING MATERIAL, MINOR STRUCTURES	5	TN		
6	300	FOUNDATION CONDITIONING GEOTEXTILE	15	SY		
7	310	15" RC PIPE CULVERTS, CLASS III	100	LF		
8	310	18" RC PIPE CULVERTS, CLASS III	100	LF		
9	310	24" RC PIPE CULVERTS, CLASS III	60	LF		
10	310	30" RC PIPE CULVERTS, CLASS III	60	LF		
11	310	36" RC PIPE CULVERTS, CLASS III	60	LF		
12	310	42" RC PIPE CULVERTS, CLASS III	60	LF		



13	310	15" POLYPROPYLENE PIPE	50	LF		
14	505	SHALLOW UNDERCUT	70	CY		
15	505	CLASS IV SUBGRADE STABILIZATION	100	TN		
16	520	AGGREGATE BASE COURSE	40	TN		
17	545	INCIDENTAL STONE BASE	100	TN		
18	607	MILLING ASPHALT PAVEMENT, 1.5" DEPTH	110	SY		
19	SP	PATCHING EXISTING PAVEMENT	40	TN		
20	SP	MINOR WIDENING	75	TN		
21	816	CONCRETE PAD FOR SHOULDER DRAIN OUTLET	1	EA		
22	838	ENDWALLS	5	CY		
23	840	PIPE COLLARS	5	CY		
24	SP	FLOWABLE FILL	15	CY		
25	840	MASONRY DRAINAGE STRUCTURES	2	EA		
26	840	MASONRY DRAINAGE STRUCTURES	2	CY		

27	840	MASONRY DRAINAGE STRUCTURES	4	LF		
28	840	FRAME WITH GRATE, STD 840.16, 20, 22, 24, OR 29	1	EA		
29	840	FRAME WITH TWO GRATES, STD 840.16, 20, 22, 24, OR 30	1	EA		
30	840	FRAME WITH GRATE AND HOOD, STD 840.03, TYPE E, F OR G	1	EA		
31	840	FRAME WITH COVER, STD 840.54	1	EA		
32	SP	CONCRETE APRON FOR EXISTING DROP INLET OR CATCH BASIN	3	EA		
33	SP	CONCRETE TOP SLAB (LID)	72	SF		
34	SP	MODIFIED CONCRETE MEDIAN APRON	175	SY		
35	SP	REMOVE AND REPLACE CONCRETE APRON FOR DROP INLET	1	EA		
36	846	1'6" CONCRETE CURB AND GUTTER	250	LF		
37	846	2'6" CONCRETE CURB AND GUTTER	500	LF		
38	846	SHOULDER BERM GUTTER	50	LF		
39	SP	MODIFIED CONCRETE FLUME	2	EA		
40	846	CONCRETE EXPRESSWAY GUTTER	75	LF		

41	846	CONCRETE VALLEY GUTTER	20	LF		
42	848	4" CONCRETE SIDEWALK	45	SY		
43	848	CONCRETE CURB RAMPS	10	EA		
44	848	6" CONCRETE DRIVEWAY	45	SY		
45	848	RETROFIT EXISTING CONCRETE CURB RAMPS	2	EA		
46	848	REMOVE AND REPLACE CONCRETE CURB RAMP	2	EA		
47	850	4" CONCRETE PAVED DITCH	100	SY		
48	852	5" MONOLITHIC CONCRETE ISLANDS (KEYED IN)	70	SY		
49	854	CONCRETE BARRIER, TYPE I, II, III, IV, T, T1 OR T2	20	LF		
50	857	PRECAST REINFORCED CONCRETE BARRIER, SINGLE FACED	10	LF		
51	SP	REMOVE AND REPLACE CONCRETE ISLAND	70	SY		
52	SP	REMOVE AND REPLACE DRIVEWAY APRON	50	SY		
53	SP	REMOVE AND REPLACE SIDEWALK	45	SY		
54	SP	REMOVE CONCRETE ISLAND	70	SY		

55	SP	REMOVE DRIVEWAY APRON	50	SY		
56	SP	REMOVE SIDEWALK	45	SY		
57	SP	REMOVE AND REPLACE CURB AND GUTTER	100	LF		
58	SP	REMOVE CURB AND GUTTER	250	LF		
59	SP	REMOVE CURB RAMP	2	EA		
60	858	ADJUSTMENT OF CATCH BASINS	2	EA		
61	858	ADJUSTMENT OF DROP INLETS	3	EA		
62	858	ADJUSTMENT OF MANHOLES	3	EA		
63	858	ADJUSTMENT OF METER BOXES OR VALVE BOXES	1	EA		
64	858	ADJUSTMENT OF OVERSIZED MANHOLES	1	EA		
65	858	RECONSTRUCT MANHOLE STRUCTURES	1	EA		
66	859	CONVERT EXISTING CATCH BASIN TO JUNCTION BOX	1	EA		
67	859	CONVERT EXISTING CATCH BASIN TO DROP INLET	1	EA		
68	859	CONVERT EXISTING DROP INLET TO JUNCTION BOX	1	EA		

69	859	CONVERT EXISTING DROP INLET TO CATCH BASIN	1	EA		
70	859	CONVERT EXISTING JUNCTION BOX TO DROP INLET	1	EA		
71	859	CONVERT EXISTING JUNCTION BOX TO CATCH BASIN	1	EA		
72	840	TRAFFIC BEARING DROP INLET STD 840.35	2	EA		
73	864	REMOVE AND RESET EXISTING GUARDRAIL	50	LF		
74	876	RIP RAP, CLASS I	60	TN		
75	1160	TEMPORARY CRASH CUSHIONS	1	EA		
76	1170	WATER FILLED BARRIER	50	LF		
77	1190	LAW ENFORCEMENT	100	HR		
78	SP	LANE CLOSURE, TWO LANE, TWO WAY FACILITY	12	EA		
79	SP	LANE CLOSURE, MULTILANE DIVIDED FACILITY	20	EA		
80	SP	LANE CLOSURE, UNDIVIDED MULTILANE FACILITY	30	EA		
81	SP	SHOULDER CLOSURE WITH CRASH TRUCK	5	EA		
82	SP	SHOULDER CLOSURE WITHOUT CRASH TRUCK	16	EA		

83	1605	TEMPORARY SILT FENCE	400	LF		
84	1631	MATTING FOR EROSION CONTROL	400	SY		
85	SP	PERMANENT SOIL REINFORCEMENT MAT	200	SY		
86	1642	WATTLE	80	LF		
87	1660	SEEDING AND MULCHING	1.5	ACR		

**TOTAL BID FOR PROJECT:** \_\_\_\_\_